

Comfort-Cire®

Century®

Installation, Operation & Maintenance Manual

MPC Multi-Protocol DDC Controls

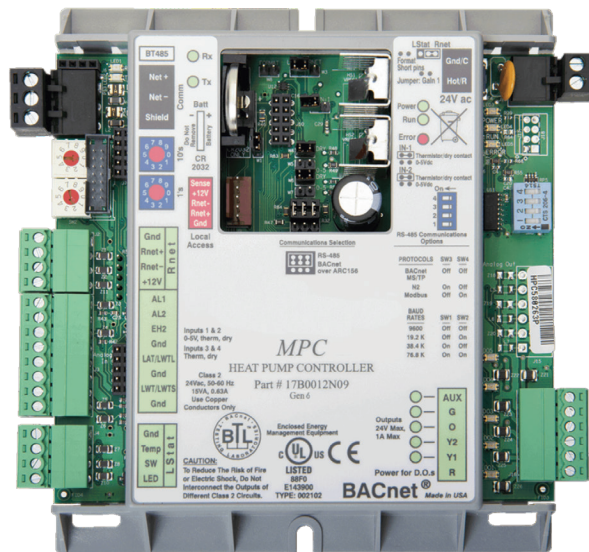

MPC MULTI-PROTOCOL DDC CONTROLS
APPLICATION, OPERATION & MAINTENANCE

97B0031N01
Revised: August 18, 2021



www.marsdelivers.com

Table of Contents

MPC Controller Overview.....	3-10
BACview6 Service Tool and Addressing	11-13
Equipment Touch Tool Overview.....	14-16
MPC LED Codes	17
MPC Sequence of Operation.....	18-23
Multi-Generation Water-to-Air Point Matrix	24-34
MPC Feature Configuration	35-37
Generation 4 Water-to-Water Points Matrix	38-43
MPC Wall Sensors	44-49
Android App Installation	50
Frequently Asked Questions (FAQs)	51
Equipment Touch Manual- Screen Descriptions (Water-to Air).....	52-69
Revision History.....	71

MPC Controller Overview

The Multi-Protocol (MPC) Heat Pump controller is a dual purpose controller. It contains the logic to perform as an advanced customizable thermostat when combined with a wall sensor and is designed to allow the integration of water source heat pump equipment into DDC systems. The MPC Controller has the ability to communicate through a choice of four widely used protocols:

1. BACnet MS/TP
2. Johnson Controls N2
3. Modbus

The protocol of choice for the particular system is selected by simply configuring DIP switches on the MPC Controller. This flexibility allows one controller, the MPC, to be used in a multitude of buildings which use any of these three common protocols.

The MPC serves as a node of information processing between the heat pump and the DDC network. The MPC commands the heat pump to heat and cool based upon sensor inputs. The MPC monitors the operation of the heat pump and communicates the operating parameters to the DDC network. The MPC will always work in conjunction with a CXM, DXM or DXM2 controller, which also resides in the heat pump control box. The MPC has factory pre-loaded application software which allows optimal control of the heat pump equipment. The MPC can run in stand-alone operation as well as with the DDC network. The heat pump arrives at the jobsite with the factory installed MPC Controller and is ready to run stand-alone and can be connected to the DDC network at any time.

Features

System Controls: In conjunction with the wall sensors, the MPC offers features such as:

- Room temperature sensing.
- Local setpoint adjustment.
- Local override into Occupied Mode.
- LED for alarm status.
- LED for fault status type.
- Heat pump reset at the wall sensor.
- Digital room temperature display.
- Information from the wall sensors can be reported to the DDC network system.
- Various combination sensors support temperature control, humidity control, CO2 control, occupancy control, and VOC control.
- Supports water to air application or water to water applications.
- The MPC can be programmed with a 7-day schedule.
- One binary aux output can be programmed to control various functions.

Communications: The Multi-Protocol communications provides DDC system flexibility.

- Supports native BACnet MS/TP communications (the ASHRAE standard protocol for interoperability).
- Supports Modbus communications for integration into Modbus DDC networks.
- Four baud rate levels offer flexible communications speeds of 9600, 19.2k, 38.4k, or 76.8k baud.
- High speed 16-bit Processor with 1024 kBytes RAM and 4096 kBytes Flash Memory which allows MPC programs to be upgraded and easily downloaded in the field.
- Removable field wiring connectors for ease of field service.
- Engineered for quality and reliability.
- Enables building operators to easily upgrade firmware in the future.
- Program archival feature.
- Supports up to five ASW 016, 017, or 018 (RNet) sensors
- Supports Equipment Touch maintenance and configuration tool.

Added Features on Gen 7 (Water-to Air)

- Ability to operate in heating or cooling only mode.
- Ability to operate in full time electric or external heat mode.
- Ability to archive the current control program.
- Input for pressure switch for dirty filter notice applications.
- Can operate without ASW sensor if so equipped with an Equipment Touch unit (temperature and humidity only) (lead/Lag)
- Can alternate compressor (lead/lag) based on manual control, timed control or compressor accumulated time. High time compressor becomes secondary or lag at beginning of next heat/cool cycle.
- Supports Android based tablet in place of Equipment Touch (does not support temp/humidity control).
- Selectively supports zone averaging using up to 5 ASW wall sensors. (See appendix for details)
- The Equipment Touch user interface replaces the old BACView6 tool on the Gen 7 MPC. New tool is backward compatible with previous versions (Gen 4, 5, 6) of the MPC.

MPC Controller Overview

Figure 1: Typical System

Water to Air Heat Pump

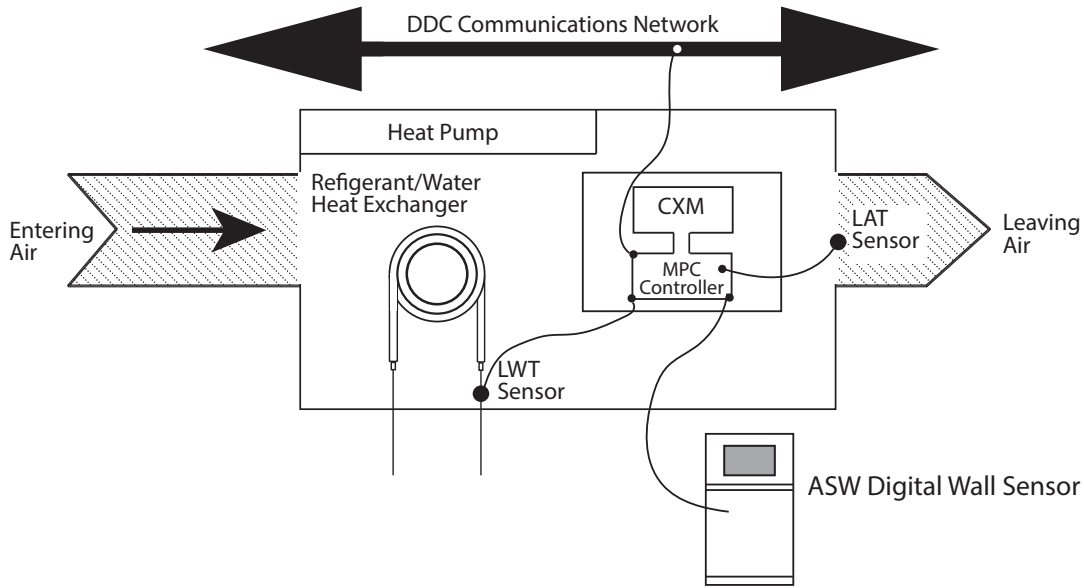
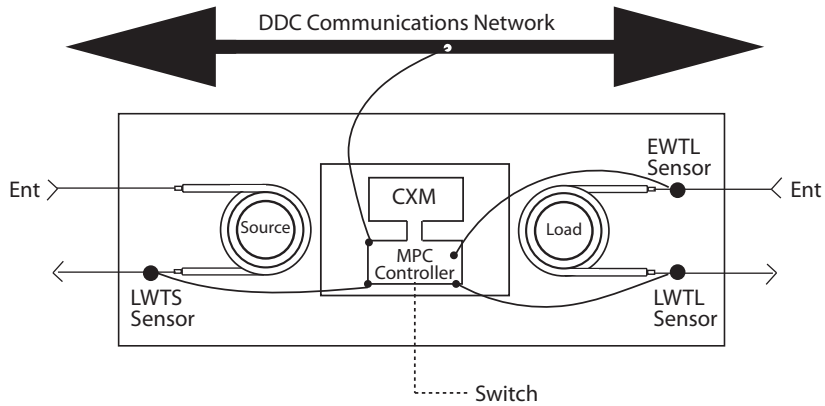

Figure 2: Typical System

Water to Water Heat Pump



MPC General Specifications

Power:	24VAC \pm 10%, 50 or 60Hz, 15VA max. power consumption.
Size:	5-1/16" [129mm] width x 5-11/16" [144mm] height x 1-1/2" [38mm] (minimum panel depth).
Housing:	Rugged GE C2905HG Cyclopol plastic housing (complies with UL 94 V-O).
Environmental:	0-130°F (-17.8 to 54.4 °C), 10% to 95% non-condensing.
Protection:	Surge & transient protection circuitry for the power and I/O. Optical isolation for communications port.
Processor/Memory:	High speed 16-bit processor with 1024kB RAM and 4096kB flash memory.
LED Indicators:	Individual LEDs for digital outputs, power, run, error, transmit, and receive.
Compliance:	UL916; FCC Part 15, Subpart B, Class A; ICES, Class A; EN55022, Class A; IEC61000-6-1; RoHS complaint, WEEE Complaint; BTL listed
I/O Point Count:	5 digital outputs (on-board relays rated for 1A resistive at 24VAC). 6 universal inputs (IN-1 and IN-2 are jumper selectable for dry contact or 0-5VDC). 1 analog wall sensor port for non-communicating (LStat) wall sensors. 1 digital wall sensor port for communicating (RNet) wall sensors.
Communications:	EIA-485 communications port using twisted pair. A two position DIP switch allows for manual selection of desired protocol. Available protocols are BACnet MS/TP, Johnson Controls N2, Modbus and LonWorks (requires Loc daughter card). Another 2 position DIP switch allows for manual selection of desired baud rate. Available baud rates are 9600, 19.2k, 38.4k, and 76.8k.
Addressing:	2 rotary switches are provided for setting the individual controller's primary network address (for more information on network addressing, see Addressing & Power Up).
Wall Sensor:	The wall sensors provide room temperature sensing with digital display, local setpoint adjust, local override, LED for alarm status and fault type indication, and heat pump reset. The wall sensors require between 2 and 5 wires depending on the type of sensor used.
Mounting Hole Dimensions:	Two mounting holes center line as below with 5-9/16" [141mm] height spacing. Factory mounted.

Figure 3:

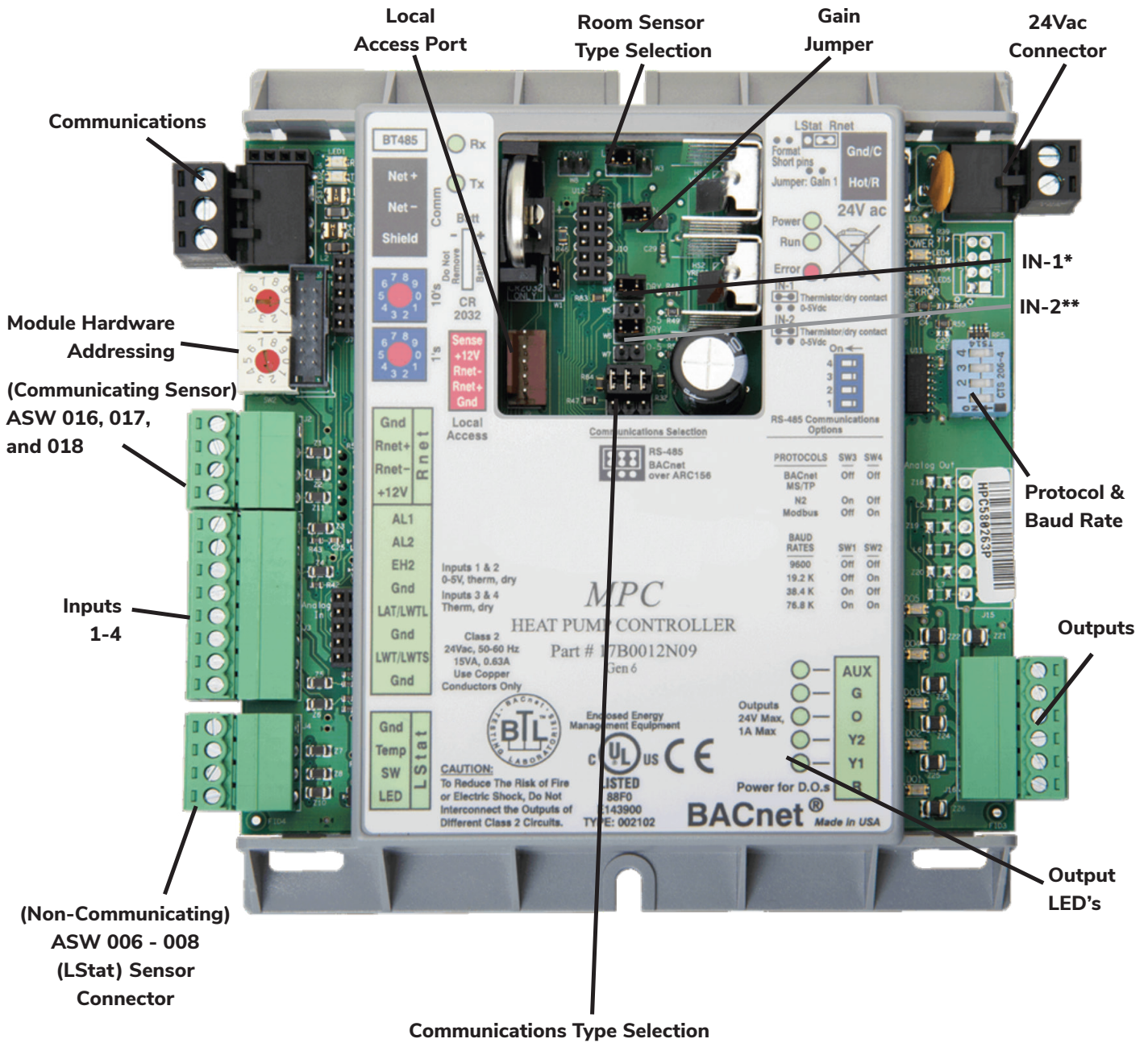

Physical Dimension: 5.88" (149.4mm) x 5.66" (143.8mm)

Figure 4:

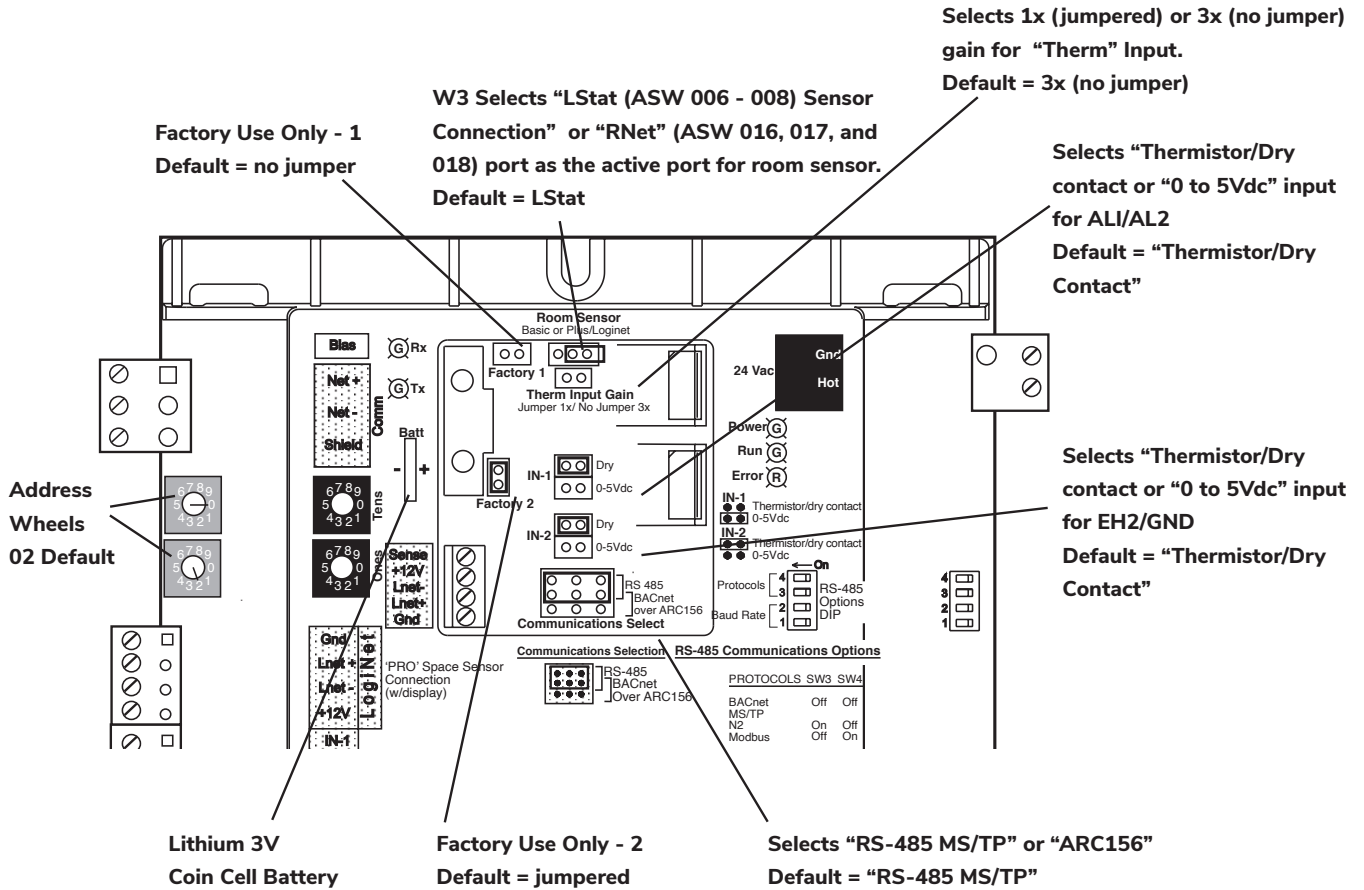

The MultiProtoCol (MPC) Heat Pump controller has a Lithium 3V coin cell battery, CR2032, which provides a minimum of 10,000 hours of data retention during power outages. The CR2032 does not have a clip. It can simply be pulled from the socket using thumb and forefinger. Observe correct polarity while removing and replacing. **Note: When replacing batteries, leave power applied to prevent potential loss of data.** The battery should be replaced at least every 5 years to ensure data retention when the unit is not powered. The life cycle of the batteries does not include any 'shelf life' before the battery was originally installed and put to use.

⚠ CAUTION! ⚠

CAUTION! Complete shutdown of the main power to the Heat Pump and/or MultiProtoCol (MPC) Heat Pump controller for an extended period of time will leave only the on board battery for data retention.

MPC Controller Overview

Communications Selection

When the Communications Selection jumper is in the “BACnet over ARC156” position, DIP switch selectors SW1, SW2, SW3, and SW4 are all disabled. BACnet protocol is selected and the baud rate is also selected to be 156 kbps.

When the communications port is configured for the ARC156, use a ARC156 cable available from Automated Logic.

When the communications port is configured for RS-485 communications, use standard dedicated 22AWG-18AWG twisted pair wire.

For complete details on wiring, termination, for BACnet MS/TP, refer to ANSI/ASHRAE 135-1995, clause 9.2.2. Refer to the Application Note for the BACnet devices that you will be interfacing with for specific wiring.

Communications Wiring Instructions

1. Be sure the module's power is off before wiring it to the ARC156 or RS-485 communications bus.
2. Check the network communication wiring for shorts and grounds.
3. Connect the ARC156 or RS-485 wires and shield to the module's screw terminals as shown in Figure 5. Be sure to follow the same polarity as the rest of the ARC156 or RS-485 communications network.
4. Power up the module.
5. Proper communications for all protocols and baud rates can be verified by making sure the transmit (Tx) and receive (Rx) LEDs are active.

Protocol Configure

The communications port on the MPC has Multi-Protocol capability which means the MPC can be configured to communicate via BACnet, Johnson Controls N2, or ModBus communication protocols. This configuration is done via the “Communications Selection” jumper and the 4-position DIP switch package (SW1, SW2, SW3, SW4) located on the MPC. The communications port's baud rate is also set with this same 4-position DIP switch package. See Figure 6 below.

Note: If using ARC156 wiring, then only BACnet protocol can be used. When using RS-485 wiring, any of the 3 protocols (BACnet, N2, ModBus) can be used.

Figure 5: Wiring the ARC156

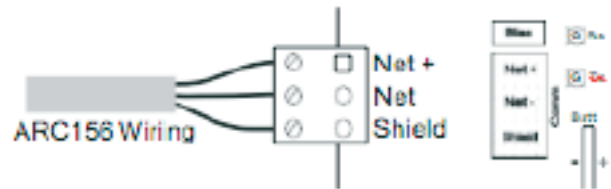
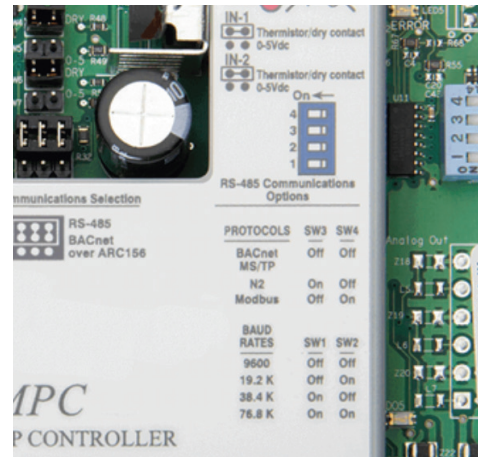

Figure 6: Communications Selections



MPC Controller Overview

BACnet Setup – The MPC can be set up to communicate via “BACnet over ARC156” or “BACnet MS/TP”. Refer to Table 1 for setup.

N2 Setup – N2 must be configured for RS-485 communications with a baud rate of 9600, using 8 data bits, no parity, and 1 stop bit. The MPC is always an N2 subordinate. Refer to Table 1 for setup.

ModBus Setup – ModBus must be configured for RS-485 communications. Baud rate can be selected from 38.4 kbps, 19.2 kbps, or 9.6 kbps. Refer to Table 1 for setup.

Table 1: Communications Set Up

Desired Set Up	Communications Selection Jumper	RS-485 Communications Options DIP			
		Baud Rate		Protocol	
		SW1	SW2	SW3	SW4
BACnet Set Up					
BACnet over ARC156 (156kbps baud rate)	BACnet over ARC156	Doesn't Matter		Doesn't Matter	
BACnet MS/TP (76.8 kbps baud rate)	RS-485	On	On	Off	Off
BACnet MS/TP (38.4 kbps baud rate)	RS-485	On	Off	Off	Off
BACnet MS/TP (19.2 kbps baud rate)	RS-485	Off	On	Off	Off
BACnet MS/TP (9.6 kbps baud rate)	RS-485	Off	Off	Off	Off
N2 Set Up					
N2 (9.6 kbps baud rate)	RS-485	Off	Off	On	Off
MODbus Set Up					
MODBus (38.4 kbps baud rate)	RS-485	On	Off	Off	On
MODbus (19.2 kbps baud rate)	RS-485	Off	On	Off	On
MODbus (9.6 kbps baud rate)	RS-485	Off	Off	Off	On

Additional Information

Room Sensors

The MPC is designed to work with specific sensors. Two types of sensors may be used:

1. LStat
2. RNet

The LStat sensor is a non-communicating thermistor based sensor and the RNet is a digital communicating sensor.

The RNet connection is at the upper left of the MPC and the LStat is at the lower left. Both are four to five wire sensors. The MPC comes from the factory with the room sensor jumper set for LStat sensor. To utilize the RNet sensors the jumper must be changed to RNet.

The use of the RNet sensor allows for an extra input into the MPC. When using a unit equipped with ClimaDry® Reheat, a combination temperature and humidity sensor is required. Refer to ASW section.

It is also possible to use the equipment touch as a wall sensor if only temperature or temperature and humidity are required. See the Equipment Touch IOM for specific instructions on enabling the Equipment Touch internal sensors. The ASW 006, 007, 008 are LStat sensors. The ASW 016, 017, 018 are RNet sensors.

ASW 016, 017 and 018 can be purchased with a temperature only sensor, temperature and humidity sensors (HUC suffix) or temperature and CO2 sensors (COC suffix).

Retrofitting MPC to Existing Units

The MPC can be added to any unit with the CXM, DXM, or DXM2 control. A retrofit kit has been assembled with the control, necessary wiring and additional sensors. Part number is ACNTRL06.

LAT

The leaving air temperature is reported to the BMS. LAT control is not supported.

iGate Communication

On units equipped with a DMX2 control, the iGate functions are not available when the MPC is installed. The Service Tool can be connected directly to the DXM2 – to access the DXM2 control board functions. The MPC does not access these functions.

Additional Inputs

The AL1/AL2 and EH2/GND inputs are available with either type of sensor. Two additional inputs are available when the RNet sensor is used. These are Temp/GND and SW/GND.

AL1/AL2 and EH2 input terminals can accept 0-5VDC, Thermistor, or dry contact signals. Terminals LAT/LWTL and LWT/LWTS accept thermistor or dry contact signals.

LAT/LWTL and LWT/LWTS come with leaving air and leaving water temperature thermistors installed but can be repurposed. The Lstat terminals can be used for an additional thermistor input (Gnd/Temp) and SW can be used as a dry input contact.

The MPC allows custom factory programming of the various inputs to accomplish various sequence of operations as the building may require.

The MPC can be programmed with a 7 day program.

MPC Inputs

Terminals	Type	Notes
AL1	Dry Contact or 0-5V	
AL2	Dry Contact or 0-5V	
EH2/GRND	Dry Contact or 0-5V	
LAT/LWTL	Dry Contact or Thermistor (analogue)	
LWT/LWTS	Dry contact or Thermistor (analogue)	
LSTAT or TEMP/GRND	Optional Thermistor (analogue)	When Using ASW 016-018
LSTAST or SW/GRND	Optional Thermistor (analogue)	When Using ASW 016-018

BACview6 Service Tool and Addressing

Not Available on Some Units

For existing installations only! For new installations use

Equipment Touch Service Tool (BACview6 or Equipment Touch is required to set up unit)

BACview6 is used for MPC gen6 and earlier. BACview6 is still used on all W x W units.

The BACview6 Service Tool provides local access to control and operational properties of equipment. The BACview6 plugs into an RNet connection (local access port) and allows you to display and modify defined properties without any computer software. The BACview6 features a numeric keypad, directional keys, and four function keys. A large 4-line by 40-character backlit LCD display is provided for easy reading even in poor lighting conditions. The device also includes an alarm indicator light and audible warning.

Part#1: ABACVIEW6

Part#2: ABACVIEW6A (cable)

Figure 7:



HOW TO WIRE ABACVIEW to ABACVIEW6A

When prompted for password.
Password: 1111

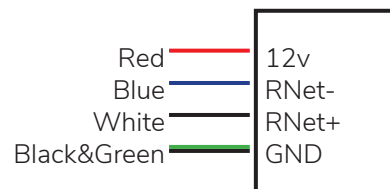

BACview6 Service Tool and Addressing

Addressing & Power Up

Before setting or changing the module's hardware address, make sure the MPC Controller power is off. The MPC only reads the address when the module is booted up. The MPC has two rotary switches for assigning the module's hardware address. One switch corresponds to the "tens" digit and the second switch corresponds to the "ones" digit, allowing for hardware based addressing of up to address 99. For example, if the module's address is three, set the tens switch to zero and the ones switch to three. The station ID for each MS/TP node must be unique on a MS/TP segment. The MPC's rotary address switches are used to set this unique ID.

Figure 8: Setting Module Address

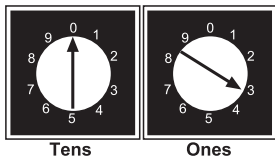

After setting the address, apply power to the MPC, the Run, Error, and Power LEDs should turn on. The Run LED should begin to blink and the Error LED should turn off.

Note: Set address for heat pump #1 (HP-1) at 02 per typical BMS naming conventions. All other heat pump addresses should be assigned as HP# + 1.

Changing the device instance when using a network of more than 99 MPC units

The Gen 4, 5 and 6 MPC allows the device instance to be changed using the BACview6 service tool. This feature allows an installation with more than 99 MPC-based units to be set and managed on-site rather than factory preset.

In order to change the device instance, the MPC must be powered up. Connect the BACview6 service tool to the MPC using the local access port. When the main screen appears, scroll down to "Manual Control" using the down arrow and press "Enter";

At the "Manual Control" screen, press "Enter" with "Unit Configuration" highlighted and again with "BAC-net" highlighted. The following screen should appear:

Figure 9:

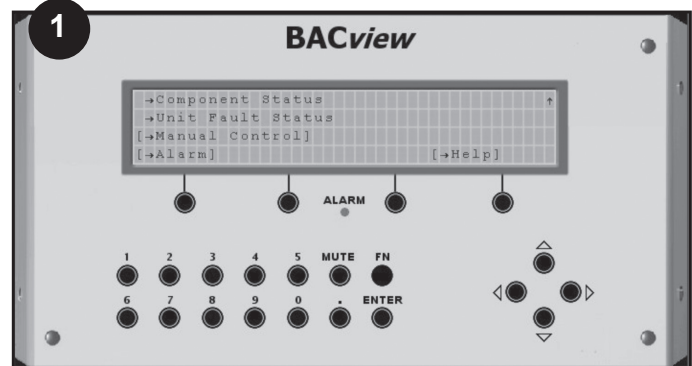

BACview6 Service Tool and Addressing

Addressing & Power Up

Figure 10:

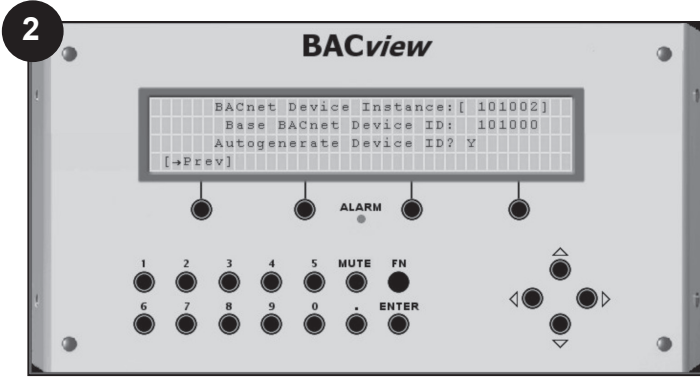
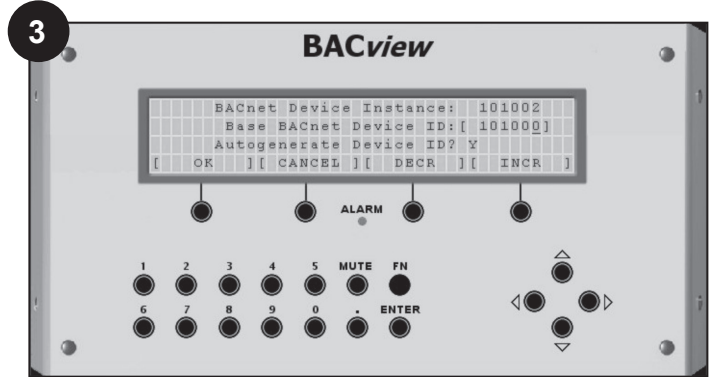

Figure 11:



The device instance is typically six digits long. The last two digits correspond to the addressing rotary dials so these should not be changed using the BACview6.

To change the device instance, use the down arrow to highlight the numbers beside "Base BACnet Device ID" and press "Enter". Leave the leading zeros (ex: "0001", "0002"). You will be prompted for an Admin Password, the password is 1111. A cursor underlining the final digit of the "Base BACnet Device ID" will appear.

Figure 12:

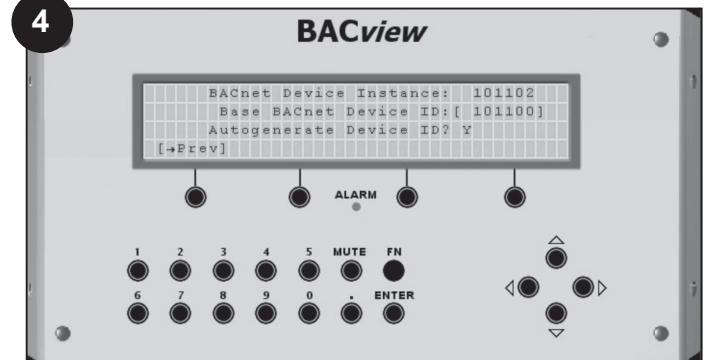

Equipment Touch Service Tool Overview

Figure 13:



Wire the Equipment Touch to the controller's RNet port. The RNet port can have one Equipment Touch device and up to five RNet (ASW 016, 017, or 018) sensors.

Note: The Equipment Touch RNet port does not support RS Sensors.
When prompted for password: Password = 9999

Equipment Touch Service Tool Overview

The Equipment Touch (Figure 13) is a touchscreen device with a 4.3 inch color LCD screen that is connected to an MPC GEN 7 Controller Unit. It provides access to most all internal control/ status points and alarms that would normally require access to the system server (WebCTRL) to access. The Equipment Touch replaces the BACVIEW 6 service tool and includes additional features. Equipment Touch does not currently support water to water applications. The Equipment Touch (or EQT) can also function as a wall sensor providing temperature and humidity data to the controller when configured to do so. The EQT connects to the MPC Controller's RNet Port in the same manner as the RNet Wall Sensors and can reside with up to 5 RNet Sensors. Each MPC GEN 7 Controller can support up to 5 RNet Sensors and one EQT (Figure 14 and 15).

A software version of EQT that works on most Android devices is also available. (See appendix for additional information).

Figure 14: Basic Equipment Touch connection program

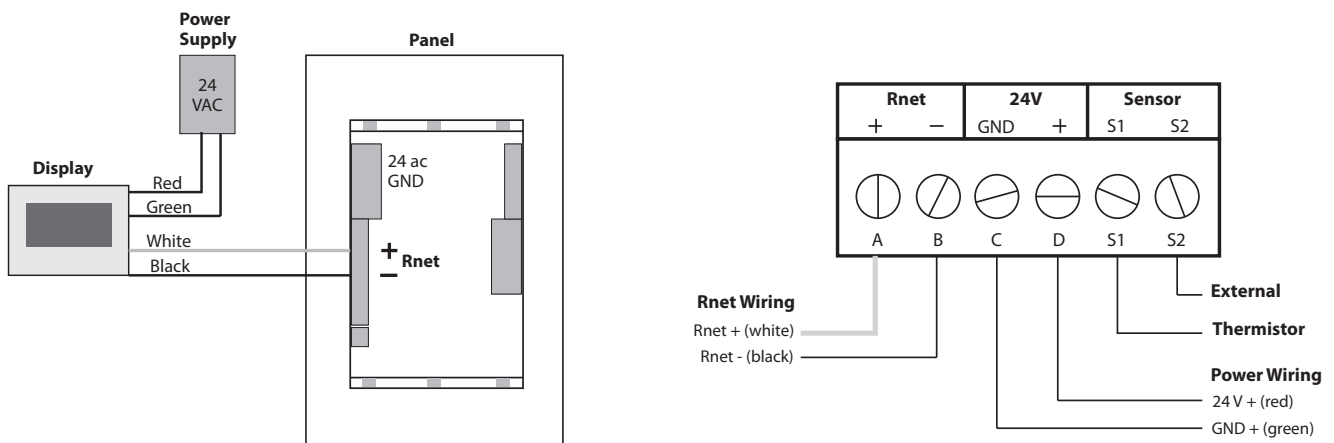
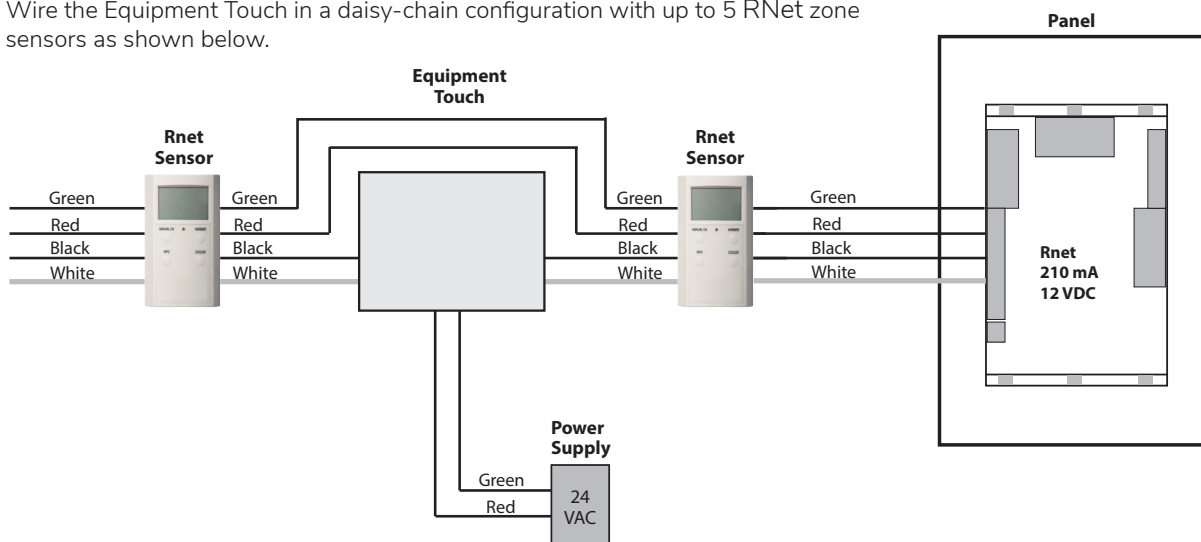

Figure 15: Equipment Touch wiring diagrams

- Wire the Equipment Touch in a daisy-chain configuration with up to 5 RNet zone sensors as shown below.



Note- The Equipment Touch does not require the user to set an address for it.

Equipment Touch Mounting Details

Wiring and Mounting the Equipment Touch

1. Remove the backplate from the Equipment Touch:
 - a. Hold the Equipment Touch as shown in the image below.

Figure 16:



- b. While firmly pressing the two tabs on top of the Equipment Touch, pull on the back-plate with your index finger until the back-plate releases from the Equipment Touch.
2. Pull the communication cable, power cable and external thermistor wiring (if applicable) through the large hole in the center of the backplate.
3. Partially cut, then bend and pull off the outer jacket of the RNet cable(s). Do not nick the individual wire insulation.
4. If wiring 1 cable to the Equipment Touch, cut the shield wire off at the outer jacket, then wrap the cable with tape at the outer jacket to cover the end of the shield wire. If wiring 2 cables in a daisy-chain configuration, twist together the shield wires, then wrap the cable with tape.
5. Strip about 0.25 inch (0.6) of insulation from the end of each wire.
6. Connect wiring to the Equipment Touch as shown below:

Figure 17:

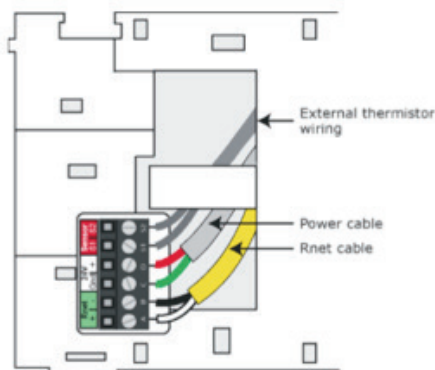

7. Attach the backplate to the wall or panel.

If mounting in or on a panel:

 - a. Drill two 3/16 inch (4.8mm) pilot holes in the panel.
 - b. Attach a backplate using pan head 6-32 x 3/8" to 1/2" long machine screws. Do not over tighten screws to prevent damage to plastic housing. Recommendation: Use Loctite 220 on screw threads if the Equipment Touch will be subject to vibration.
8. Attach the Equipment Touch to the backplate:
 - a. Place the bottom of the equipment touch onto the backplate by aligning the 2 slots on the Equipment Touch with the tabs on the backplate.
 - b. Push the Equipment Touch onto the backplate until the tabs at the top of the Equipment Touch snap onto the backplate.
9. Turn off the controller's Power.
10. Connect the other end of the RNet wiring to the controller's RNet port or to a zone sensor.

Notes - Insert the shield wire with the ground wire into the controller's GND terminal. Use the same polarity throughout the RNet.
11. Connect power wiring to a 24 Vac power supply.
12. Turn on the controller's power.

⚠ CAUTION! ⚠

Allow no more than 0.6 inch (1.5mm) of bare communication wire to protrude. If bare communication wire contacts the cables foil shield, shield wire or a metal surface other than the terminal block, the device may not communicate correctly.

MPC LED Codes

The MPC Controller has the following LEDs:

- Power - lights when power is on.
- Run - blinks when the processor is running.
- Error - lights when an error is detected.
- Receive (Rx) - lights when the comm port receives data.
- Transmit (Tx) - lights when the comm port transmits data.
- Digital Output - lights when the associated digital output turns on.

LED Power-Up Sequence

During power-up, the module goes through an initialization and self test sequence.

Proper module power-up can be verified by observing the LEDs as follows:

1. The Run and Error LEDs turn on and begin blinking.
2. The Error LED then turns off.
3. The Run LED continues blinking.

Note: The Error LED flashes three times in sync with the Run LED when the module is being formatted. The Run LED should never stop flashing. If it stops flashing for 1.5 seconds, the watchdog timer will reset the module.

Overcurrent Protection

The MPC Controller is protected by internal solid state polyswitches (polymeric PTC, resettable overcurrent protection device, also called PPTC) on the incoming power. The overcurrent protection circuitry is a positive temperature coefficient (PTC) thermistor that increases in resistance as it warms up and stays in that mode until the power is removed. Once the power is removed, the polyswitch resistance lowers to operational level as the device cools down. After power has been re-applied, the unit will operate properly if the fault condition has been removed.

It is not necessary to remove power on the communication line in order to reset the solid state overcurrent circuit. Once the power level is low enough, the overcurrent circuit cools down to operating temperature. A blown polyswitch can indicate incorrect wiring during installation. Generally, a blown polyswitch indicates a power surge was received by the board.

Digital Output LEDs

There are 5 digital outputs on the MPC. One output (AUX) can be custom configured to control an external device (1 amp at 24VAC.). G, O, Y2, and Y1 are required to operate the heat pump and are connected to the CXM, DXM or DXM2 board.

Table 2: MPC Flash Codes

Run LED	Error LED	Condition	Action
2 flashes per second	OFF	Normal	Expected behavior of a configured controller
2 flashes per second	2 flashes, alternating with Run LED	Five minute auto-restart delay after system error	Controller will count down the five minutes, then attempt to restart normally if the condition that caused the fault returns to normal. Disconnect all wiring and see if the controller will restart normally.
2 flashes per second	3 flashes then OFF	Module has just been formatted	This condition should not occur with a configured controller. Memory archive ensures the controller will always have a configuration.
2 flashes per second	4 flashes then pause	Two or more devices on this network have the same ARC156 network address	Disconnect the comm connector then assign a unique network address.
2 flashes per second	6 flashes then OFF	Module's response to a LonTalk 'wink' command received from a LonWorks Network Management Tool	N/A
2 flashes per second	ON	Exec halted after frequent system errors or GFB's halted	N/A
5 flashes per second	ON	Exec start-up aborted, Boot is running	If this condition occurs you have two options: <ul style="list-style-type: none"> • Manual restore of memory from archive • Download memory
5 flashes per second	OFF	Firmware transfer in progress, Boot is running	Normal behavior during a memory download
7 flashes per second	7 flashes per second, alternating with Run LED	Ten second recovery period after brownout	Precedes the brownout condition
14 flashes per second	7 flashes per second, alternating with Run LED	Brownout	Check power supplied to the controller

MPC Sequence of Operation

Fan Operation – Digital output point G (DO4) is the fan output and is connected to the "G" terminal on the CXM, DXM or DXM2 control. If Fan Mode is set to "Auto", then the fan is energized only during a call for heating or cooling. "Auto" Mode is the default mode of operation. **At 30% PID, the fan(G) energizes in Auto Mode.**

Heating/Cooling Changeover – The Digital output "O" (DO3) is the RV output and is connected to the "O" terminal on the CXM, DXM or DXM2 control. "O" is energized during call for cooling. **The RV (O) energizes at 40% PID in cooling only.**

Compressor Operation – The Digital outputs Y1 (DO1) and Y2 (DO2) are the outputs for compressors stage 1 and 2. Y1 is connected to Y terminal on the CXM/DXM/DXM2 and if the heat pump is dual stage, Y2 is connected to a second CXM Y input or Y2 on the DXM/DXM2.

Y1 and Y2 are off when the zone temperature is between the heating and cooling set points. As the zone temperature rises above cooling set point or below heating setpoint, **Y1 is energized at 50% PID and Y2 is energized at 75%.**

There is also a load sharing mode which permits swapping the primary status of Y1 with Y2 depending on compressor run time. The low time compressor becomes primary and the high time compressor assumes secondary status.

Note: All 5 digital outputs have associated LEDs to indicate operating status. If the digital output is on, then the associated LED will be on.

Occupied/Unoccupied Changeover – When the MPC is in the stand-alone mode of operation, the MPC defaults to the Occupied Mode of operation. Occupancy changeover may be provided through the communications network.

Troubleshooting Tips – If the BMS is having trouble communicating with the MPC, check the following items before contacting technical support.

- Make sure the MPC wiring is correct. Make sure all color codes match and that no wire strands are shorting over to other terminals.
- Make sure the MPC and other network controllers have power and are turned on. Make sure all equipment has power and LEDs lit with no solid error light. Some devices, especially communication devices, receive power from a source other than a power cable or adapter. Some panels can be reinitialized by resetting the panel.
- Verify operation of all LEDs: RX, TX, Power, Run, DOs and Error.
- Make sure that all jumpers are set to default and that there is nothing jumped on the format pin.

MPC Sequence of Operation

Water -to-Water Start Up Check

1. Unit powered up and running.
2. LED check: Rx, Tx, Power, Run and no solid **RED** error LED.
3. Program initializing schedule status for Occupied Mode (default) or Unoccupied Mode will determine set point range. Occupied set points will be defaulted to 53 cooling and 105 heating. If a schedule is implemented, the unoccupied set points will default to 73 cooling and 85 heating.
4. The Program will determine if the unit is either a Master or Subordinate.
5. The Program will control the water temperature based on the Entering Water Temperature (EWT) Load Sensor. This can be changed to control based off of the LWT via BAS or BACview6 service tool.
6. The Program will check for which water temperature set point to use based on Heating Mode or Cooling Mode.
7. In a water to water application, the mode has to be manually changed via Bacnet or with BACview6 service tool. If it is in heating, it will permanently stay in Heating Mode until it is changed to Cooling Mode.
8. Like water to air, Y1 will come on a 50% and Y2 at 75% and not off until the EWT/LWT conditions have been satisfied.
9. 5-minute delay is built in between compressor cycles.
10. While the unit is on, the program will continue to monitor the CXM/DXM/DXM2 control for faults. If a fault event occurs and the unit is in Lockout Mode, the relay will close (IN1/AL1/AL2/GND) and the fault code is transmitted via EH2 output to the EH2 input on the MPC. This is available through BAS network points. A history counter will also keep track of past and present faults which can also be seen via BAS or BACview6.
11. The MPC can also function in Metric Mode (Celsius Mode).

Water-to-Air Startup Check- Equipment Touch Method

1. Unit is Powered up?
 - YES: Go to step 2
 - NO: Apply power to MPC.
2. Check LED status.
 - a. **Green** (TxD) LED should be blinking rapidly.
 - b. **Green** power LED should be on solid .
 - c. **Green** run LED should be blinking at 1-2 blinks per second.
 - d. **RED** error LED should be off.
 YES: Go to step 3.
3. Power down MPC and wire up the Equipment Touch Service Tool and RNet Sensor(s). Once these are installed, power MPC back up. The Equipment Touch should power up and display the "Main" (Home)

Figure 18: Menu screen



4. Navigate to the "Sensor Setup and Status" screen by pressing **<MPC Setup/Status>** then **<Sensor Setup/Status>** buttons. Press the **<ZS Sens Active>** button. This should display the correct address and number of ZS Sensors that are attached to the MPC. Press the **<Back>** and go to the "ZS Sensor Setup" screen where you will enable the alarms for each sensor installed and detected in the previous step.
5. From the EQT menu press **<Temp Setup and Status>** then press **<Temp Units>**. "Current Mode" should be set to **<Fahrenheit>**. If this is ok, you are finished here and can move on to Step 5. Otherwise uncheck the **"Metric Mode"** (BV:39) point to set the MPC to Fahrenheit Mode. Make sure the "Current Mode" changes to "FAHRENHEIT" before pressing **<BACK>** and exiting this screen.

MPC Sequence of Operation

From the **<Temp Setup and Status>** screen press **<Temp Setpoints>**.

- The default settings for the Fahrenheit and Celsius operation modes are listed here in this screen. If your setpoints differ from the default values listed here, please enter them in the appropriate box.

Table 3:

Description	Fahrenheit°	Celsius°
Master Zone Temp	73.0	22.7
Unoccupied Dead Band	17	9.44
Occupied Dead Band	2	1.11
Unoccupied Heat Setpoint	82	27.7
Occupied Cool Setpoint	74	23.3
Subordinate Heat Setpoint	72	22.2
Subordinate Cool Setpoint	74	23.3

- Press the **<Manual SP>** button to go to the "MANUAL SP" Screen in which you can edit the Manual Setpoint Adjust Range. It is defaulted to +/- 5° Fahrenheit or +/- 2.8° Celsius. This will allow you to have a 10°F / 4.6°C adjustment range of the setpoint from the sensor. If you would like a different range, please enter it now.

Note: If it is set to zero, no adjustment can be made from the Wall Sensor.

- The MPC will default to RNet Sensors. If you have LStat Sensor types, set jumper W3 to LStat.
- From the "MPC Setup/Status" screen press **<Compressor Setup>**. Check the compressor settings to ensure all are set to the default factory settings. "Load Balance Select" controls the stage assignment of compressors. The default setting assigns Compressor 1 as primary and Compressor 2 as secondary. **Note: For single compressor systems C1 should always be primary.**

Table 4:

Description	Point	Default
Load Balance Select	AV:59	2
Compressor Shut Down	BV:53	Unchecked
C1 Manual	BV:30	Unchecked
C2 Manual	BV:31	Unchecked
C1 Runtime Reset	BV:2	Unchecked
C2 Runtime Reset	BV:5	Unchecked
C1 Cycle Reset	BV:21	Unchecked
C2 Cycle Reset	BV:22	Unchecked

- From the "MPC Setup/Status" screen press **<Heat/Cool Control>**. Ensure that the following points are set to the default values. The default values enable both the Heating and Cooling Modes and ensures the reversing valve is not in Manual Mode. If you need "Heat Only" or "Cool Only" Modes, uncheck the appropriate enable for the mode you wish to disable. 99% of all applications will have both enabled.

Table 5:

Description	Point	Default
Heat Mode Enabled	BV:61	Checked
Cool Mode Enabled	BV:54	Checked
Reversing Valve Manual	BV:30	Unchecked

- From the **<MPC Setup/Status>** screen press **<Fan/Filter Control>**. Check the following points for the correct default values. The Supply FAN is configured to cycle anytime the compressor is "ON".

Table 6:

Description	Point	Default
Emergency Shutdown	BV:8	Unchecked
Supply Fan Manual	BV:28	Unchecked
Supply Fan Configure	AV:33	1
Dirty Filter Reset	BV:7	Unchecked
Dirty Filter Interval	AV:30	1500
Dirty Filter Mode	BV:60	Time
Dirty Filter Sense	BV:59	Unchecked
Fan Speed Enable	BV:51	Unchecked
Fan Speed Trigger Type	AV:56	75%

- From the "MPC Setup/Status" screen press **<Heat/Cool Control>**. Check Occupancy BV:12 and make sure it is set to "Occupancy".
- From the "MPC Setup/Status" screen press **<AUX Outputs>**. Check the "AUX CFG" setting for the default value of 1. This is Emergency Electric Heat. If other functions are needed please consult the Control Points Matrix for other functional settings associated with this point.

MPC Sequence of Operation

14. From the "MPC Setup/Status" screen press **<Maintenance>**. From this screen, you can adjust the temperature setpoint and watch the function of the MPC. You can remove the Y1, Y2 output wires to keep unit from going into Heat or Cool Mode for this operation.
 1. You should see both the Occupied Icon and the "AUX Mode = Emergency ELEC Heat". If there is no RNet Sensor with a humidity sensor installed, the "RH" Icon will be equal to 0.0.
 2. Read the Zone Temperature and adjust the Zone Heating Setpoint at least 2° above the Ambient Zone Temperature. (You can use the RNet Sensor or the Equipment Touch for this operation). You should be able to observe the "Heat PID" Icon start increasing as the MPC is set to go into a heating cycle.
 - a. When the PID value increases above 30% the Fan Icon for the Supply Fan will appear.
 - b. When the PID value rises above 40%, the RV Icon will disappear (assuming Cooling Mode was last active) indicating the Reversing Valve is not energized.
 - c. When the PID value reaches 50% the Compressor stage 1 turns on and the C1 icon appears, assuming the anti-short cycle delay has expired.
 - d. If the space temperature is not increasing, the PID will continue increasing until it reaches 75% when Compressor 2 turns on and the C2 icon appears. If the PID increases above 90% the Emergency Electric Heat (AUX) Output will be energized.
 - e. Decrease the Heating Setpoint 2° below the Zone Temperature and the Heating PID will begin to decrease.
 - f. When the PID value falls below 90%, the "AUX" Output will turn off. When it falls below 75%, C2 will turn off.
 - g. When the PID value falls below 50%, the compressor output, C1, will turn off. When it falls below 40% the Supply Fan will turn off.
 3. Read the Zone Temperature and adjust the Zone Cooling Setpoint at least 2° below the Ambient Zone Temperature. You should observe the Cool PID start increasing as the MPC is set to go into a Cooling cycle.
 - a. When the PID value increases above 30% the Fan Icon for the Supply Fan will appear.
 - b. When the PID value rises above 40% the RV Icon will appear indicating the Reversing Valve is energized.
 - c. When the PID value reaches 50% Compressor stage 1 turns on and the C1 icon appears assuming the anti-short cycle delay has expired.
 - d. If the space temperature is not decreasing, the PID will continue increasing until it reaches 75% when Compressor 2 turns on and the C2 Icon appears.
 - e. Increase the cooling setpoint 2° above the Zone Temperature and the Cooling PID value will begin to decrease.
 - f. When the cooling PID value falls below 50% the compressor output, C1, will turn off. When it falls below 40% the Supply Fan will turn off.

MPC Sequence of Operation

Water-to-Air Startup Check- BACview6 Method

1. Unit is powered up?
 - YES: Go to step 2
 - NO: Apply power to MPC.
2. Check LED status.
 - a. **Green** (TxD) LED should be blinking rapidly.
 - b. **Green** Power LED should be "ON" solid (not blinking).
 - c. **Green** Run LED should be blinking at 1-2 blinks per second.
 - d. **RED** error LED should be "OFF".
 - YES: Go to step 3.
 - No: check wiring and cycle power. If LED status still cannot be confirmed, call technical support.
3. Power down the MPC and wire up the BACview6 Service Tool and ZS Sensor(s). When they are installed, apply power to the MPC. The BACview6 should turn on and display the "Main" (Home).

Figure 19: Main menu screen

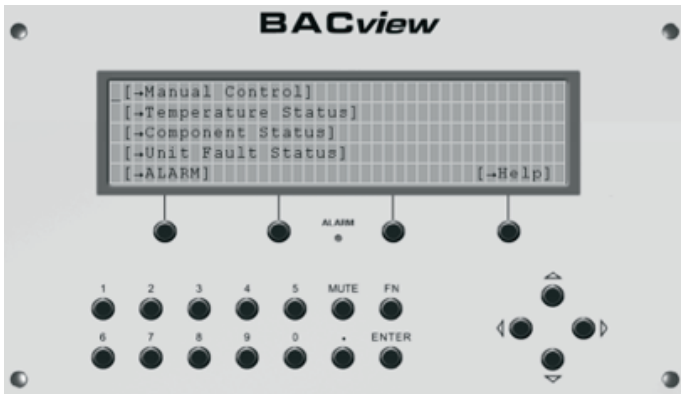

4. Navigate to the "Sensor Setup and Status" screen by highlighting **[Manual Control]** and clicking **<Enter>**, then highlighting **[Unit Control]**, and clicking **<Enter>**. Scroll down the list and make sure the following are set correctly.

Table 7:

Description	Point	Default
Test Mode		OFF
Reversing Valve Output		OFF
Supply Fan Output		OFF
Compressor 1 Output		OFF
Compressor 2 Output		OFF
Auxiliary Output		OFF
Supply Fan Mode		AUTO
Dirty Filter Interval		1500
Emergency Shutdown		OFF
Heating Mode		ON
Cooling Mode		ON
Dirty Filter Mode		Time
Load Balance Select		2
EXT OCC/ Dirty FILT Sens		OCC
Archive Enable		OFF
RNet Sens1 Enable		ON
RNet Sens2 Enable		OFF
RNet Sens 3 Enable		OFF
RNet Sens4 Enable		OFF
RNet Sens5 Enable		OFF

5. Navigate to "AUX Output Configuration" by highlighting **[Manual Control]** and clicking **<Enter>**, then highlighting **[Unit Configuration]**, and clicking **<Enter>**. Scroll down the list and make sure "AUX OUTPUT" Configuration is set to 1 and Supply Fan Configuration is set to 1.
6. Navigate to "Zone Temperature Control" settings by highlighting **[Manual Control]** and clicking **<Enter>**, then highlighting **[Zone Temperature Control]**, and clicking **<Enter>**. Scroll down the list and make sure "Occupied Mode" is set to Occupied and "Metric Mode" is OFF.

MPC Sequence of Operation

7. Adjust the temperature setpoint from the RNet Wall Sensor.
 1. Read the Zone Temperature and adjust the "Zone Heating Setpoint" at least 2° above the ambient Zone Temperature. (You can use the RNet Sensor). You should observe the Heat PID increase via WEBCTRL (if it is being used). The MPC should now be set to go into a Heating Cycle.
 - a. When the PID value increases above 30% the SF (Supply Fan) LED will illuminate on the MPC Unit.
 - b. When the PID increases above 40% the RV Icon will disappear indicating the Reversing Valve is off.
 - c. If the space temperature is not increasing, the PID value will continue increasing until it reaches 75% when Compressor 2 turns on and the C2 icon appears.
 - d. Decrease the Heating Setpoint 2° below the Zone Temperature and the Heating PID will begin to decrease (check with WEBCTRL or BMS).
 - e. When it falls below 90%, C2 will turn off.
 - f. When it falls below 50%, C1 will turn off and when it falls below 30% the Supply Fan LED will turn off.
 2. Read the Zone Temperature and adjust the Zone Cooling Setpoint at least 2° below the ambient Zone Temperature. (You can use the RNet Sensor or WEBCTRL for this operation). You will observe the Cooling PID start increasing via WEBCTRL as the MPC is set to go into a Cooling Cycle.
 - a. When the PID rises above 30% the SF (Supply Fan) will illuminate indicating the Fan has cycled on.
 - b. When the PID rises above 40% the RV (Reversing Valve) LED will illuminate indicating the Reversing Valve has cycled on.
 - c. When the PID gets above 50%, the Compressor C1 LED will illuminate after a 2 minute delay.
 - d. Increase the Cooling Setpoint 2° above the Zone Temperature and the Cooling PID will begin to decrease.
 - e. When it falls below 50%, C1 will turn off. When the PID goes below 30% the SF will shut off.



Multi Generation Water-to-Air Points Matrix (Read Left to Right Across Spread)

Point Name	Type	Number	Read/Write	Type	Register	Type	ID	NV Name	Default
	BACNet			ModBus		N2		LON	
Archive Status	MSV	10	R	NA	NA	NA	NA	NA	NA
Zone Temp	AI	1	R	Float	30001	Analog In	1	Special*	NA
Actual CL Setpoint	AV	1	R	Float	30007	Data Float	1	nvoActCLSP	74° F
Actual HT Setpoint	AV	2	R	Float	30009	Data Float	2	nvoActHTSP	72° F
Occupied CL SP/ Fahrenheit	AV	3	R/W	Float	40001	Data Float	3	NA	74° F
Master ZT/ Fahrenheit	AV	4	R/W	Float	40003	Data Float	4	nviMasterZT	73° F
Occupied Deadband/ Fahrenheit	AV	5	R/W	Float	40005	Data Float	5	nviOccDB	2° F
Pulse Signal Value	AV	6	R	Float	30011	Data Int	1	nviPSV	1
Unoccupied CL SP/ Fahrenheit	AV	7	R/W	Float	40007	Data Float	6	NviUnOccDB	82° F
Override Time Remaining	AV	8	R	NA	NA	NA	NA	NA	NA
Subordinate HT SP/ Fahrenheit	AV	9	R/W	Float	40011	Data Float	8	nviSubordinateHTSP	72° F
Subordinate CL SP/ Fahrenheit	AV	10	R/W	Float	40009	Data Float	7	nviSubordinateCLSP	74° F
HP Fault Counter	AV	11	R	Float	30014	Data Int	2	Special*	0
LP Fault Counter	AV	12	R	Float	30015	Data Int	3	Special*	0
LT1 Fault Counter	AV	13	R	Float	30016	Data Int	4	Special*	0
LT2 Fault Counter	AV	14	R	Float	30017	Data Int	5	Special*	0
CO Fault Counter	AV	15	R	Float	30018	Data Int	6	Special*	0
Over/Under Voltage Fault Counter	AV	16	R	Float	30019	Data Int	7	Special*	0
UPS Fault Counter	AV	17	R	Float	30020	Data Int	8	Special*	0
Swapped LT1/LT2 Fault Counter	AV	18	R	Float	30021	Data Int	9	Special*	0
C1 Cycle Counter	AV	19	R	Float	30022	Data Int	10	Special*	0
C2 Cycle Counter	AV	20	R	Float	30023	Data Int	11	Special*	0
Occupied HT Setpoint	AV	21	R/W	Float	40051	Data Float	34	nviOccHTSP	72° F
Occupied HT Setpoint Celsius	AV	22	R/W	Float	40053	Data Float	35	Special*	22.2° C
Unoccupied HT Setpoint	AV	23	R/W	Float	40055	Data Float	36	nviUnOccHTSP	65° F
Unoccupied HT Setpoint Celsius	AV	24	R/W	Float	40057	Data Float	37	Special*	18.3° C
HT PID	AV	28	R	Float	30024	Data Float	17	nvoHtPID	0
CL PID	AV	29	R	Float	30026	Data Float	18	nvoClPID	0

Gen 3	Gen 4	Gen 5	Gen 6	Gen 7	Description
				X	Reports the status of the archival process.
	X	X	X	X	Raw Space Temperature from the Wall Sensor, RNet and RS sensors.
X	X	X	X	X	Actual cooling setpoint based upon occupancy status, setpoint adjustment and metric conversion.
X	X	X	X	X	Actual heating setpoint based upon occupancy status, setpoint adjustment and metric conversion.
	X	X	X	X	Network setpoint for the cooling setpoint (Fahrenheit) in Occupied Mode.
X	X	X	X	X	Fahrenheit network setpoint for multiple MPC's sharing the same space temperature sensor. Only for subordinate units when (BV:16) is "ON".
X	X	X	X	X	Creates the Fahrenheit Heating Setpoint using Occupied Cooling Setpoint minus current value when using Deadband Mode. Minimum value is 2° F. DB Mode: (BV:48) must be "ON".
X	X	X	X	X	Indicates the last fault code in memory on the CXM/DXM/DXM2 board. Refer to CXM/DXM/DXM2 manual for fault code descriptions.
X	X	X	X	X	Network setpoint for the Fahrenheit Cooling Setpoint in Unoccupied Mode.
X	X				Obsolete point found only in Gen 3 and Gen 4
X	X	X	X	X	Network Input for the actual Fahrenheit Heating Setpoint when used as a subordinate unit. This input is only used for subordinate units when the M/S Switch (BV:16) is "ON".
X	X	X	X	X	Network Input for the actual Fahrenheit Cooling Setpoint when used as a subordinate unit. This input is only used for subordinate units when the M/S Switch (BV:16) is "ON".
X	X	X	X	X	Indicates the number of High Pressure Faults since startup or the last reset via Fault Reset (BV:24).
X	X	X	X	X	Indicates the number of Low Pressure Faults since startup or the last reset via Fault Reset (BV:24).
X	X	X	X	X	Indicates the number of Liquid Temperature 1 Faults since startup or the last reset via Fault Reset (BV:24).
X	X	X	X	X	Indicates the number of Liquid Temperature 2 Faults since startup or the last reset via Fault Reset (BV:24).
X	X	X	X	X	Indicates the number of Condensate Overflow Faults since startup or the last reset via Fault Reset (BV:24).
X	X	X	X	X	Indicates the number of Over/Under Voltage Faults since startup or the last reset via Fault Reset (BV:24).
X	X	X	X	X	Indicates the number of UPS Faults since startup or the last reset via Fault Reset (BV:24).
X	X	X	X	X	Indicates the number of swapped LT1/LT2 faults since startup or the last reset via Fault Reset (BV:24).
X	X	X	X	X	Indicates the number of times Compressor 1 has cycled ON/OFF more than 6 times in one hour since startup or the last reset via Fault Reset (BV:24).
X	X	X	X	X	Indicates the number of times Compressor 2 has cycled ON/OFF more than 6 times in one hour since startup or the last reset via Fault Reset (BV:24).
		X	X	X	Network input for the Fahrenheit Occupied Heating Setpoint when not using Deadband Mode. DB Mode (BV:48) must be "OFF".
		X	X	X	Network input for the Celsius Occupied Heating Setpoint when not using Deadband Mode. DB Mode (BV:48) must be "OFF".
		X	X	X	Network input for the Fahrenheit Unoccupied Heating Setpoint when not using Deadband Mode. DB Mode (BV:48) must be "OFF".
		X	X	X	Network input for the Celsius Unoccupied Heating Setpoint when not using Deadband Mode. DB Mode (BV:48) must be "OFF".
X	X	X	X	X	Heating PID based on the setpoint and actual space temperature in Percent (%).
X	X	X	X	X	Cooling PID based on the setpoint and actual space temperature in Percent (%).

Multi Generation Water-to-Air Points Matrix - cont'd

(Read Left to Right Across Spread)

Point Name	Type	Number	Read/Write	Type	Register	Type	ID	NV Name	Default
	BACNet			ModBus		N2		LON	
Dirty Filter Interval	AV	30	R/W	Float	40027	Data Float	19	nviDFI	1500 Hrs
AUX CFG	AV	31	R/W	Float	29	Data Float	20	nviAuxCfg	1
TSTAT Mode	AV	32	R/W						1
SF CFG	AV	33	R/W	Float	33	Data Float	22	nviSfCfg	1
Zone Temp Status	AV	34	R	Float	30028	Data Float	23	nvoZTStatus	NA
LVG Air Temp Status	AV	35	R	Float	30030	Data Float	24	nvoLAT	NA
LVG Air Water Temp Status	AV	36	R	Float	30032	Data Float	25	nvoLWT	NA
Manual SP Adjust	AV	37	R/W	Float	40035	Data Float	26	nviManSPAdj	5° F
Master ZT Celsius	AV	38	R/W	Float	40037	Data Float	27	Special*	22.7° C
Unoccupied CL SP Celsius	AV	39	R/W	Float	40039	Data Float	28	Special*	27.7° C
Occupied Deadband Celsius	AV	40	R/W	Float	40041	Data Float	29	Special*	1.1° C
Subordinate CL Setpoint Celsius	AV	41	R/W	Float	40043	Data Float	30	Special*	23.3° C
Subordinate HT Setpoint Celsius	AV	42	R/W	Float	40045	Data Float	31	Special*	22.2° C
Occupied CL SP Celsius	AV	43	R/W	Float	40047	Data Float	32	Special*	23.3° C
Manual Setpoint Adj Celsius	AV	44	R/W	Float	40049	Data Float	33	Special*	2.7° C
Unoccupied Deadband	AV	45	R/W	Float	40015	Data Float	10	Special*	17.0° F
RV Status	BV	13	R	DI	10006	BI	6	nvoRVStatus	NA
Work Schedule	BV	14	R/W	NA	NA	NA	NA	NA	NA
UPS Signal	BV	15	R	DI	10007	BI	7	Special*	NA
M/S Switch	BV	16	R/W	DO	8	BI	8	nviMS	OFF
C1 Runtime Alarm	BV	17	R	DI	10008	BI	8	Special*	NA
C2 Runtime Alarm	BV	18	R	DI	10009	BI	9	Special*	NA
Dirty Filter Alarm	BV	19	R	DI	10010	BI	10	nvoDFAlarm	NA
Valid Sensor Alarm	BV	20	R	DI	10011	BI	11	nvoVSAAlarm	NA
C1 Cycle Reset	BV	21	R/W	DO	9	BO	9	Special*	OFF
C2 Cycle Reset	BV	22	R/W	DO	10	BO	10	Special*	OFF
Lockout Alarm	BV	23	R	DI	10012	BI	12	nvoLOAlarm	NA
Fault Counter Reset	BV	24	R/W	DO	11	BO	11	Special*	OFF

Gen 3	Gen 4	Gen 5	Gen 6	Gen 7	Description
	X	X	X	X	Time Interval for the time based Dirty Filter Replacement Alarm.
	X	X	X	X	Sets Configuration parameters for the AUX output Relay (W). See AUX CFG SETTINGS section below.
X		X			Determines method of Temp Control in GEN 3 Hardware.
X	X	X	X	X	Sets Configuration parameters for the Supply Fan.
	X	X	X	X	Network Output for Space (Room Temp)Temperature. Celsius /Fahrenheit.
	X	X	X	X	Leaving Air Temperature for WSHP. Celsius/ Fahrenheit.
	X	X	X	X	Leaving Water Temperature for WSHP. Celsius/ Fahrenheit.
	X	X	X	X	Network Input for User Defined Fahrenheit Setpoint Adjustment. Should not be used with LStat Sensors If = 0 cannot adjust SP at ASW.
	X	X	X	X	Celsius Network Input for multiple WSHP sharing the same Space Sensor. This is only for Subordinate units where the M/S Switch is (BV:16) "ON".
	X	X	X	X	Network Input for the Celsius cooling setpoint in the Unoccupied Mode.
	X	X	X	X	Creates the Celsius Heating Setpoint using Occupied Cooling Setpoint minus current value when using the Dead Band Mode. Minimum Value is 1.11° C. DB Mode (BV:48) must be "ON".
	X	X	X	X	Network input for the actual Celsius Cooling Setpoint when used as a subordinate unit. This input is only used for subordinate units where the M/S Switch (BV:16) is "ON".
	X	X	X	X	Network input for the actual Celsius Switch Heating Setpoint when used as a subordinate unit. This input is only used for subordinate units where the M/S Switch (BV:16) is "ON".
	X	X	X	X	Network Input for the Celsius cooling setpoint in the Occupied Mode.
	X	X	X	X	Network Input for user defined Celsius Setpoint Adjustment. Should not be used with RS Pro Sensors.
	X	X	X	X	Creates the Fahrenheit heating setpoint using Unoccupied Cooling Setpoint minus current value when using Deadband Mode. Minimum value is 2° F. DB Mode (BV:48) value must be "ON".
X	X	X	X	X	Indicates the Reversing Valve Status (ON/ OFF).
X	X	X	X	X	Reads Schedule from BMS and informs controls whether they are in Occupied or Unoccupied Mode.
X	X	X	X	X	Indicates if the UPS Mode is ON/OFF. Refer to CXM/DXM/DXM2 AOM for UPS Definition.
X	X	X	X	X	Master/Subordinate network input to enable the use of Master ZT. Master unit is defined as one WSHP per sensor and the default value is "OFF". Subordinate is defined as a unit that does not have it's own wall sensor and that shares a wall sensor with Master unit and the value is "ON".
X	X	X	X	X	Indicates the number of operational hours for C1 has exceeded 5000. Reset via C1 Reset(BV:2).
X	X	X	X	X	Indicates the number of operational hours for C2 has exceeded 5000. Reset via C2 Reset(BV:5).
X	X	X	X	X	Indicates the number of Supply Fan operational Hours has exceeded the Dirty Filter Interval setting. Reset via Dirty Filter Reset (BV:7)
X	X	X	X	X	Indicates there is no valid Room Sensor connected to the MPC Unit.
X	X	X	X	X	Network Input to reset the C1 Cycle Counter (AV:20) back to zero.
X	X	X	X	X	Network Input to reset the C2 Cycle Counter (AV:20) back to zero.
X	X	X	X	X	Indicates the CXM/DXM/DXM2 is in Lockout Mode.
X	X	X	X	X	Network Input used to reset the historical counters for each fault code back to zero.

Multi Generation Water-to-Air Points Matrix - cont'd (Read Left to Right Across Spread)

Point Name	Type	Number	Read/Write	Type	Register	Type	ID	NV Name	Default
	BACNet			ModBus		N2		LON	
C1 Cycle Alarm	BV	25	R	DI	10013	BI	13	Special*	NA
C2 Cycle Alarm	BV	26	R	DI	10014	BI	14	Special*	NA
AUX Status	BV	27	R	DI	10015	BI	15	nvpAuxStatus	NA
SF Manual	BV	28	R/W	DO	12	BO	12	nviSFMan	OFF
RV Manual	BV	29	R/W	DO	13	BO	13	nviRVMan	OFF
C1 Manual	BV	30	R/W	DO	14	BO	14	nviC1Man	OFF
C2 Manual	BV	31	R/W	DO	15	BO	15	nviC2Man	OFF
TSTAT Reset	BV	33	R/W	ADF	28	Coil	29	nviTstatMode	OFF
AUX Manual	BV	32	R/W	DO	16	BO	16	nviAuxMan	OFF
Test Mode	BV	34	R/W	DO	18	BO	18	nviTestMode	OFF
Test Mode Alarm	BV	38	R	DI	10025	BI	21	Special*	NA
Metric	BV	33	R/W	DO	21	BO	28	Special*	OFF
AUX Toggle	BV	40	R/W	DO	17	BO	17	nviAuxToggle	OFF
Unoccupied Deadband Celsius	AV	46	R/W	Float	40017	Data Float	11	Special*	9.44° C
Relative Humidity Setpoint	AV	47	R/W	Float	59	Data Float	38	nviRHSP	60%
Relative Humidity Deadband	AV	48	R/W	Float	61	Data Float	39	nviRHDB	5%
Relative Humidity Status	AV	49	R	Float	34	Data Float	40	nvoRHStatus	NA
Aux 5 Temp	AV	50	R	Float	36	Data Float	41	nvoAux5Temp	NA
Aux 6 Temp	AV	51	R	Float	38	Data Float	42	nvoAux6Temp	NA
CO2 Status	AV	52	R	Float	40	Data Float	43	nvoCO2Status	NA
VOC Status	AV	53	R	Float	42	Data Float	44	Special*	NA
CO2 Trip point	AV	54	R/W	Float	63	Data Float	45	nviCO2Trip	800 PPM
VCO Trip point	AV	55	R/W	Float	65	Data Float	46	Special*	800 PPM
FAN Speed Trigger	AV	56	R/W	Integer	67	Data Int	12	nviFanSpdTrig	75%
Airflow Fault Counter	AV	57	R	Integer	44	Data Int	13	Special*	0
Pump Fault Counter	AV	58	R	Integer	45	Data Int	14	Special*	0
Application Type	AV	99	R	Float	13	Data Float	9	NA	NA

Gen 3	Gen 4	Gen 5	Gen 6	Gen 7	Description
X	X	X	X	X	Indicates the Compressor C1 has cycled ON/OFF more than 5 times during 1 hour.
X	X	X	X	X	Indicates the Compressor C2 has cycled ON/OFF more than 5 times during 1 hour.
X	X	X	X	X	Indicates the AUX output (W) is OFF/ON.
X	X	X	X	X	Manual Switch to turn Supply Fan (OFF/ ON). Only works while in Test Mode.
X	X	X	X	X	Manual Switch to turn Reversing Valve (OFF/ ON). Only works while in Test Mode.
X	X	X	X	X	Manual Switch to turn Compressor C1 (OFF/ ON). Only works while in Test Mode.
X	X	X	X	X	Manual Switch to turn Compressor C2 (OFF/ ON). Only works while in Test Mode.
		X			Obsolete Point found only in Gen 5.
X	X	X	X	X	Manual switch to turn AUX Output (W) (OFF/ ON). Only works while in Test Mode.
	X	X	X	X	Network input used to bypass normal operations in order to operate the unit manually, maximum ON time for Test Mode is 60 minutes.
	X	X	X	X	Indicates the unit is still in Test Mode after the Test Mode timer has expired.
	X	X	X	X	Network input used to define inputs and outputs. Celsius- ON / Fahrenheit- OFF.
	X	X	X	X	Network input used to toggle the auxiliary output (W) "ON" and "OFF". Used when AUX CFG (AV:31) is set to a value of 11.
	X	X	X	X	Creates the Celsius Heating Setpoint using Unoccupied Cooling Setpoint minus current value when using the Deadband Mode. Minimum value is 1.1° C . DB Mode (BV:48) must be "ON".
		X	X	X	Network input for the Dehumidification Setpoint above which the Auxiliary Output (W) is activated when AUX CFG (AV:31) is set to 12 for Humidity Control.
		X	X	X	Creates dehumidification turn off point using Relative Humidity SP minus the RH current value when AUX CFG (AV:31) is set to 12 for Humidity Control.
		X	X	X	Network Output for Space Relative Humidity when using appropriate sensor.
		X	X	X	Network Output for Auxiliary Temperature 5 when RNet Mode (BV:44) is "ON" and AUX 5 CFG (BV:47) is set to "ON" for temperature sensor.
		X	X	X	Network Output for Auxiliary Temperature 6 when RNet Mode (BV:44) is "ON" and AUX 6 CFG (BV:46) is set to "ON" for temperature sensor.
		X	X	X	Network Output for Space CO2 level when using the appropriate sensor.
		X	X	X	Network Output for Space VOC level when using the appropriate sensor.
		X	X	X	Network Input for CO2 trip point above which the Auxiliary Output is activated when AUX CFG (AV:31) is set to13 for CO2 Control.
		X	X	X	Network Input for VOC trip point above which the Auxiliary Output is activated when AUX CFG (AV:31) is set to 14 for VOC control.
			X	X	Network input for Heating or Cooling PID above which the AUX Output (W) turns "ON" when AUX CFG is set to 5 for Fan Speed Control. Requires field wired relay for PSC motors only.
			X	X	Indicates the number of airflow faults that have occurred since unit startup or resetting the fault counter via Fault Count Reset (BV:24).
			X	X	Indicates the number of pump faults that have occurred since unit startup or resetting the fault counter via Fault Count Reset (BV:24).
		X	X	X	Factory use only.

Multi Generation Water-to-Air Points Matrix - cont'd

(Read Left to Right Across Spread)

Point Name	Type	Number	Read/Write	Type	Register	Type	ID	NV Name	Default
	BACNet			ModBus		N2		LON	
Alarm State	BV	1	R	DI	10001	BI	1	nvoAlarmState	NA
C1 Reset	BV	2	R/W	DO	1	BO	1	Special*	OFF
C1 Status	BV	3	R	DI	10002	BI	2	nvoC1Status	NA
System Reset	BV	4	R/W	DO	2	BO	2	nviSystemReset	OFF
C2 Reset	BV	5	R/W	DO	3	BO	3	Special*	OFF
C2 Status	BV	6	R	DI	10003	BI	3	nvoC2Status	NA
Dirty Filter Reset	BV	7	R/W	DO	4	BO	4	nviDFReset	OFF
Emergency Shutdown	BV	8	R/W	DO	5	BO	5	nviESD	OFF
Supply Fan Operational Mode	BV	9	NA	NA	NA	NA	NA	NA	
SF Status	BV	10	R	DI	10004	BI	4	nvoSFStatus	NA
Occupied Status	BV	11	R	DI	10005	BI	5	nvoOccStatus	NA
Occupied Mode	BV	12	R/W	DO	7	BO	7	N/A	ON
Air Duct Mode	BV	41	R/W	DO	26	BO	30	nviDuctMode	OFF
AUX 5	BV	42	R	DI	10026	BI	22	nvoAux5	NA
AUX 6	BV	43	R	DI	10027	BI	23	nvoAux6	NA
RNet Mode	BV	44	R/W	DO	27	BO	31	nviRNetMode	ON
Humidity Occupancy	BV	45	R/W	DO	28	BO	32	nviRHOcc	OFF
Aux 5 Config	BV	46	R/W	DO	29	BO	33	nviAux5Cfg	ON
Aux 6 Config	BV	47	R/W	DO	30	BO	34	nviAux6Cfg	ON
DB Mode	BV	48	R/W	DO	31	BO	35	nviDBMode	OFF
CO2 Alarm	BV	49	R	DI	10028	BI	24	nvoCO2Alarm	NA
VOC Alarm	BV	50	R	DI	10029	BI	25	Special*	NA
Fan Speed Enable	BV	51	R/W	DO	32	BO	36	Special*	
Compressor Shutdown	BV	53	R/W	DO	33	BO	37	Special*	OFF
Fault	MSV	1	R	NA	NA	NA	NA	NA	
AUX Config Status	MSV	2	R	NA	NA	NA	NA	NA	
Zone Mode Status	MSV	3	R	NA	NA	NA	NA	NA	
Heating Mode	BV	61	R/W	DI	78	BI	74	Special*	ON

Gen 3	Gen 4	Gen 5	Gen 6	Gen 7	Description
X	X	X	X	X	"ON" indicates a lockout condition exists, "OFF" indicates normal operation.
X	X	X	X	X	Network Input used to reset the C1 Runtime Alarm (BV:17) once the event is triggered
X	X	X	X	X	Indicates if Compressor 1 is "ON" or "OFF".
X	X	X	X	X	Network Input used to reset the unit from Lockout Mode. User must turn it "ON" then turn it "OFF", not a momentary switch.
X	X	X	X	X	Network Input used to reset the C2 Runtime Alarm (BV:17) once the event is triggered
X	X	X	X	X	Indicates if Compressor 2 is "ON" or "OFF".
X	X	X	X	X	Network Input used to reset the Dirty Filter Alarm (BV:19).
X	X	X	X	X	Network Input for Emergency Shutdown. When engaged, Y1,Y2,G & W output relays turn "OFF".
	X	X			Sets Supply Fan Mode: OFF=auto fan / ON=fan on GEN 2, GEN 3 and GEN 4 only
X	X	X	X	X	Indicates if the Supply Fan is "ON" or "OFF".
X	X	X	X	X	Indicates whether the WSHP is in Occupied "ON" or Unoccupied "OFF" Mode.
X	X	X	X	X	Network Input to put WSHP in Unoccupied Mode "OFF" or Occupied Mode "ON". Can be used instead of Work Schedule.
		X	X	X	Network Input used to activate Air Duct Mode. The Air Duct Mode uses Aux 5 Temp for the controlling Zone Temperature.
		X	X	X	Indicates the status of Aux Input 5 when RNet (BV:44) is "ON". And AUX5 CFG (BV:46) is set to "OFF" for Binary Input.
		X	X	X	Indicates the status of Aux Input 6 when RNet (BV:44) is "ON". And AUX6 CFG (BV:47) is set to "OFF" for Binary Input.
		X	X	X	Network Input used to select between LStat (ASW 006-008) wall sensors and communicating wall sensors(ASW 016-018). RNet should be "OFF" when using LStat Sensors and "ON" for all other configurations. The MPC board jumper W3 must be set to LStat for LStat sensors or RNet for RNet sensors.
		X	X	X	Network Input used to enable/ disable humidity control when AUX CFG (AV:31) set to 12 .
		X	X	X	Network input used to select the configuration of Auxiliary Input 5. Setting RNet (BV:44) "ON" sets input for Thermistor Mode,"OFF" sets input for Dry Contact Mode.
		X	X	X	Network input used to select the configuration of Auxiliary Input 6 .Setting RNet (BV:44) "ON" sets input for Thermistor Mode,"OFF" sets input for Dry Contact Mode.
		X	X	X	Network input to select between using separate cooling and heating setpoints. Set to "OFF" for Cooling or Heating Setpoint or "ON" for the Cooling Setpoint and deadband to determine the Heating Setpoint. Used when replacing GEN 4 or lower with GEN 6 or higher.
		X	X	X	Indicates the CO2 status (AV:52) is above the CO2 trip point (AV:54) when using an appropriate wall sensor.
		X	X	X	Indicates the CO2 status (AV:53) is above the VOC trip point (AV:55) when using an appropriate wall sensor.
			X	X	Network input to activate the auxiliary output for High Speed Fan when AUX CFG (AV:31) is set to 5 for Fan Speed Control: Required field wired relay for PSC Motors only.
			X	X	Network input used to shutdown all compressor functions, C1 and C2. Compressors Enabled = "ON", Compressors disabled = "OFF"
		X	X	X	Multi-state BACnet value for text description of current alarm state.
		X	X	X	Multi-state BACnet value for text description of current Auxiliary Output Configuration..
		X	X	X	Multi-state BACnet value for text description of current operating mode.
				X	This is used to disable heating demand when it is desired to run Cooling Mode only. "ON"= Heating Enabled, "OFF"= Heating Disabled. Special feature in GEN 6, standard feature in GEN 7.

Multi Generation Water-to-Air Points Matrix - cont'd (Read Left to Right Across Spread)

Point Name	Type	Number	Read/Write	Type	Register	Type	ID	NV Name	Default
	BACNet			ModBus		N2		LON	
Cooling Mode	BV	54	R/W	DI	77	BI	73	Special*	ON
Electric Heat Mode	BV	57	R	DI	16	BI	1	Special*	OFF
Electric Heat Demand	BV	58	R	DI	17	BI	2	Special*	OFF
Ext Occ/ Dirty Filt Sens	BV	59		DI	76	BI	80	Special*	OCC
Dirty Filter Mode	BV	60	R/W	DI	76	BI	3	Special*	TIME
Archive Enable	BV	62	R/W	DI	75	BI	4	Special*	OFF
RNet Sensor 1 Enable	BV	63	R/W	DI	74	BI	70	Special*	ON
RNet Sensor 2 Enable	BV	64	R/W	DI	70	BI	78	Special*	OFF
RNet Sensor 3 Enable	BV	65	R/W	DI	71	BI	77	Special*	OFF
RNet Sensor 4 Enable	BV	66	R/W	DI	72	BI	76	Special*	OFF
RNet Sensor 5 Enable	BV	67	R/W	DI	73	BI	75	Special*	OFF
EQ Touch Temp Enable	BV	68	R/W	DI	68	BI	72	Special*	OFF
Load Balance Select Mode	AV	59	R/W	Float	19	ADI	70	Special*	2

Gen 3	Gen 4	Gen 5	Gen 6	Gen 7	Description
				X	This is used to disable cooling demand when it is desired to run Heating Mode only. ON=Cooling Enabled, OFF=Cooling Disabled. Special feature in GEN 6, standard feature in GEN 7.
				X	This enables Full time Electric Heating. Control (W) is used to enable heating element. "ON"= Full Time Electric Heating, "OFF"= Heat Pump. (Heat Pump function is shut down in the mode and AUX provides output to drive external heating element. Requires external relay and heating element). Special feature in GEN 6, standard feature in GEN 7.
				X	Status signal is "ON" when a Heating Demand is present and in Full time Electric Heating Mode (AUX_CTL = 15). Special feature in GEN 6, standard feature in GEN 7.
				X	Selects between External Motion Sensor or Dirty Filter Air Pressure into BI:8. OCC= Occupancy, DFS= Dirty Filter Sense. Special feature in GEN 6, standard feature in GEN 7.
				X	Selects between Time Mode or DFS(Air Pressure)Mode as the method for determining the Dirty Filter Interval. For DFS (Dirty Filter) Mode set (BV:59) to DFS. Special feature in GEN 6, standard feature in GEN 7.
				X	Network input used to archive the current control program. Standard feature in GEN 7, not present in previous generations.
				X	Network input for enabling RNet Sensor 1 Present Alarm . Should be turned on if RNet1 Sensor is used
				X	Network input for enabling RNet Sensor 2 Present Alarm . Should be turned on if RNet2 Sensor is used
				X	Network input for enabling RNet Sensor 3 Present Alarm . Should be turned on if RNet3 Sensor is used
				X	Network input for enabling RNet Sensor 4 Present Alarm . Should be turned on if RNet4 Sensor is used
				X	Network input for enabling RNet Sensor 5 Present Alarm . Should be turned on if RNet5 Sensor is used
				X	Network input that allows the use of the Equipment Touch Internal Sensors for Space Temperature .
				X	Network Input used to select how the compressors are sequenced to balance Compressor Runtime.

Multi Generation Water-to-Air Points Matrix

AUX CFG Settings

AUX CFG Mode (AV:31)	Value	Gen 3	Gen 4	Gen 6	Gen 7
Electric Heat when Demand > 90%	1	X	X	X	X
Cycle w/ Y1	2	X	X	X	X
Cycle w/ G	3	X	X	X	X
Slow Opening Water Valve	4	X	X	X	X
High Speed Fan	5	X	X	X	X
Alarm Relay	6	X	X	X	X
Reheat ICM/DXM Std	7	X	X		X
Reheat ICM/DXM Rev	8	X	X		X
Reheat DXM Std	9	X	X		X
Reheat DXM Rev	10	X	X		X
Manual Control	11	X	X	X	X
Humidity Control	12			X	X
CO2 Control	13			X	X
VOC Control	14			X	X
Full time Electric Heat	15				X

Supply Fan Settings

SF CFG (AV:33)	Value	Gen 3	Gen 4	Gen 6	Gen 7
Cycle with Compressor	1	X	X	X	X
On during occupancy, cycle with Compressor during unoccupancy	2	X	X	X	X
On all the Time	3	X	X	X	X

Compressor Load Balance Select Settings

Load Balance Select Mode (AV:59)	Value	Gen 3	Gen 4	Gen 6	Gen 7
Runtime Compare Mode	1				X
Manual Mode, C1 -Stage 1/ C2-Stage 2	2				X
Manual Mode, C2 -Stage 1/ C1-Stage 2	3				X
Time Toggle Mode- Toggles every 12 Hrs	4				X

Supply Fan Configuration Settings

SF CFG (AV:33)	Value	Gen 3	Gen 4	Gen 6	Gen 7
Supply Fan is ON anytime the compressor is ON	1	X	X	X	X
Supply Fan ON only when in occupied hours and the compressor is ON	2	X	X	X	X
Supply Fan is ON all the time regardless of occupancy or compressor state	3	X	X	X	X

MPC Feature Configuration

1. **Occupancy Settings:** These control points are used to set occupancy.
 - a. **Occupancy (All Generations)** – This point (BV:12) controls whether the unit is in Occupied or Unoccupied Mode. It defaults to Occupied. It can be set and overridden via the Equipment Touch or from the BMS control program (WEBCTRL).
 - b. **Occupancy Override (Generation 7)**- is a digital input (BI:8) that receives a signal from an external motion sensor to override occupancy status. For this to function, OCC/Dirty Filter Sens (BV:59) must be set to OFF.
 - c. **Network OCC Override (Generation 7)**- BNI is used via the Network to override the occupancy status of the MPC.

2. **RNet Sensor Setup (Generation 7 only):** The Gen 7 MPC is capable of averaging up to five ZS Sensors together over the RNet link. Use one ASW 018 and up to four ASW 016 sensors. If you wish to use the sensor alarm feature, you must enable the appropriate alarm enables so that the MPC logic knows how many RNet Sensors are present.
 - a. **RNet Sensor 1 Alarm Enable**- Checking this will tell the sensor alarm logic to expect a valid sensor to be present at Sensor Address 1.
 - b. **RNet Sensor 2 Alarm Enable**- Checking this will tell the sensor alarm logic to expect a valid sensor to be present at Sensor Address 2.
 - c. **RNet Sensor 3 Alarm Enable**- Checking this will tell the sensor alarm logic to expect a valid sensor to be present at Sensor Address 3.
 - d. **RNet Sensor 4 Alarm Enable**- Checking this will tell the sensor alarm logic to expect a valid sensor to be present at Sensor Address 4.
 - e. **RNet Sensor 5 Alarm Enable**- Checking this will tell the sensor alarm logic to expect a valid sensor to be present at Sensor Address 5.

3. **AUX_CFG (All Generations):** Controls the output function of the AUX output dependent on the value of (AV: 31). See Table below.

Table 8:

AUX_CFG	Function of AUX Output	Behavior
1	Emergency Electric Heat	AUX output turns "ON" if PID > 90% in Heating Mode.
2	Cycle with Compressor	AUX output turns "ON" if PID > 90% turns "ON" when Compressor (C1) is "ON".
3	Cycle with FAN	AUX output turns "ON" when FAN (SF) is "ON".
4	Slow Opening Water Valve	AUX output turns "ON" when C1 or C2 has a demand call.
5	High Speed Fan	AUX output turns "ON" if HMODE or CMODE < Fan Speed Trigger.
6	Alarm Relay Output	AUX output turns "ON" anytime ALARM is True.
7	Reheat ICM & DXM STD	Reheat with MPC SF, C and RV "ON".
8	Reheat ICM & DXM REV	Reheat with MPC SF, C and RV "ON".
9	Reheat DXM STD	Reheat with MPC SF, C and RV "OFF".
10	Reheat DXM REV	Reheat with MPC SF, C and RV "OFF".
11	AUX Toggle	AUX will assume value of BV:40
12	Relative Humidity Mode	AUX output turns "ON" anytime RH Exceeds trip point.
13	CO2 Trip Point Exceeded	AUX output turns "ON" anytime CO2 Exceeds trip point.
14	VOC Trip Point Exceeded	AUX output turns "ON" anytime VOC Exceeds trip point.
15	Full Time Electric Heat	AUX output turns "ON" anytime there is a call for heat.

AUX_CFG= 15 (only found in Generation 7)

MPC Feature Configuration

4. **Air Duct Mode (All Generations):** Air Duct Mode (ADM) allows for the control of Zone Temperature based on the return air temperature as sensed in the air duct. To activate ADM, turn (BV:41) to "ON" and BV:44 to "ON". This requires a 10K Ω type II Duct Sensor installed into the MPC unit across the Temp Input and GND Input on the LStat Connector.
5. **Cooling Only or Heating Only Setup (Generation 7 only):** For applications that require cooling only or heating only, use the following control points:
 - a: **Heating Mode Enabled-** (BV:57) When "Heating Mode" is checked, Heating Mode is enabled. The default is checked. This allows Heating Mode to be disabled when cooling only is desired.
 - b: **Cooling Mode Enable –** (BV:54) When "Cooling Mode" is checked, Cooling Mode is enabled. The default is checked. This allows Cooling Mode to be disabled when heating only is desired.
6. **Load Balancing Mode (Generation 7 only):** Defines the mode of operation for the runtime balancing of a 2 Compressor application. The modes are set by entering the following in (AV:59):
 - a: **AV:59 = 01- Runtime Comparison Mode** - The compressor with the least runtime becomes the stage 1 compressor while the high time compressor becomes the stage 2 compressor.
 - b: **AV:59 = 02-** C1 is Stage 1, C2 is Stage 2.
 - c: **AV:59 = 03-** C2 is Stage 1, C1 is Stage 2
 - d: **AV:59 = 04- Time Toggle-** C1 and C2 swap stages every 12 hours dependent on demand.
7. **Compressor Shutdown (Generation 7 only):** To disable the compressor turn (BV:53) to "OFF".
8. **Manual Setpoint Adjust (All Generations):** Sets the maximum number of degrees the user can adjust the zone setpoint at the zone sensor. Example: If Manual Setpoint Adjust = 2 and the Master Zone Temperature = 72°F the user can adjust the temperature at the zone sensor between 70°F and 74°F. Enter the Manual Setpoint Adjust value via (AV:37) for degrees in Fahrenheit, or (AV:44) for degrees Celsius.
9. **Dirty Filter Detection Setup Options (All Generations):** The MPS will indicate a filter change is necessary based on run time or (in Gen 7 only) based on an air pressure sensor. The dirty filter indicator defaults to 1,500 hours of run time and can be changed using (AV:30)

Setup for Air Pressure Sensor (Gen 7 only):

 - a: **Dirty Filter Sensor-** Setting (BV:59) to "ON" allows Dry Contact Input 6 (SW, GND) to function as pressure input. This requires a pressure switch on the output side of the return air filter. (User supplied)
 - b: **Dirty Filter Mode:** Set (BV:60) to Pressure.
10. **Configuring the Supply Fan (All Generations):** (AV:33) is used to control the behavior of the supply fan.
 - 1 => Fan is "ON" by demand, Occupied or Unoccupied.
 - 2 => Fan is "ON" while Occupied and "ON" by demand during Unoccupied hours.
 - 3 => Fan is "ON" all the time.
11. **Test Mode (All Generations):** Test Mode is used to test the output functions of the MPC unit. This configuration will remain active for 30 minutes. To activate Test Mode, turn (BV:34) to "ON". When in Test Mode the following can be tested in the indicated order:
 - 1: (BV:28) Supply Fan Manual "ON"
 - 2: (BV: 30) C1 Manual "ON"
 - 3: (BV: 31) C2 Manual "ON"
 - 4: (BV: 32) AUX Manual "ON"
 - 5: (BV: RV) Manual "ON"
12. **Input 5 and 6: (Generation 5-7):** Generations 5 and above allow the user to use Input 5 (TEMP, GND) and Input 6 (SW, GND) for added features such as temperature monitoring or current switch sensing. With RNet Mode (BV:44) set to "ON", inputs 5 and 6 will monitor field supplied 10K Ω type II thermistors via Aux5 Temp (AV:50) and Aux6 Temp AV51. If used as a dry contact, activate Aux5 CFG, (BV:46) and/or Aux6 CFG, (BV:47). When configured as a dry contact, the user can monitor switch closure status at Aux5 (BV:42) and/or Aux6 (BV:43).

This function is only available with the following sensors (ASW 016, 017,018). Not compatible with LStat Sensors (ASW 006, 007, 008).

MPC Feature Configuration

13. Master / Subordinate Setup (All Generations):

Before attempting this setup, ensure no wall sensors are connected to the subordinate (WebCTRL) is capable of mapping points between units.

This method applies for 1 master and 1 subordinate but is scalable for 1 master and multiple subordinate units.

- 1: Turn (BV:16) to "ON" on the sensor(s) you would like to act as a subordinate.
- 2: Identify the following points in the Master Unit.
 - a: Zone Temp Status (AV:34)
 - b: Actual HTSP (AV:2)
 - c: Actual CLSP (AV:1)
 - d: Occupied Status (BV:11)
- 3: Identify the following Subordinate(s) Points.
 - a: Master ZT (AV:4)
 - b: Subordinate HTSP (AV:9)
 - c: Subordinate CLSP (AV:10)
 - d: Occupied Mode(BV:12)
- 4: Map the Master Points to the Subordinate points.
 - a: Zone Temp Status (AV:34) → Master ZT (AV:4)
 - b: Actual HTSP (AV:2) → Subordinate HTSP (AV:9)
 - c: Actual CLSP (AV:1) → Subordinate CLSP (AV:10)
 - d: Occupied Status (BV:11) → Occupied Mode(BV:12)
- 5: When the mappings are complete, verify that the subordinate Actual CLSP (AV:1) and the Actual HTSP (AV:2) match those of the master unit. This forces the subordinate(s) to mirror the operation of the master unit.

14. Using Equipment Touch as a Wall Sensor: To use the Equipment Touch as the Wall Sensor, it must first have the internal Temperature and Humidity Sensors enabled. To do this, navigate to the Sensor Setup Menu in Equipment Touch..

SETUP → TOUCHSCREEN SETUP → SENSOR SETUP

1. Set Temperature Sensor to "Internal"
2. Set Temperature Sensor Transmit to "ON"
3. Set Humidity Sensor Enable Transmit to "ON"
4. Then press SAVE

15. Archival Procedure (Generation 7): There are two archives stored within the Controller,

1. **Factory Archive** is generated at the factory or when downloaded by WebCTRL or APPLOADER.
2. **Field Archive** or application specific archive is generated by the archiving function to be discussed here.

Because of this there are separate procedures for reverting to these archives.

Factory Archive Retrieval Procedure

1. Power down the MPC
2. Change the address on the Rotary Switches to 0,0.
3. Place a jumper across the format pins W8.
4. Power up the device.
5. Run and Error LED's will blink 3 times together. This is the indication that the archive retrieval has taken place. It should take less than 10 seconds.
6. Power down the MPC and remove the jumper on the format pins W8. Reset the Rotary Switches to 0,2.
7. Power the MPC back up and it will be ready to run with the restored factory programming.

Field Archive Procedure

1. Power down the MPC
2. Change the address on the Rotary Switches to anything but 0,0. You can leave it set to 0,2.
3. Place a jumper across the format pins W8.
4. Power up the device.
5. Run and Error LED's will blink 3 times together. This is the indication that the archive retrieval has taken place. It should take less than 10 seconds to occur.
6. Power down the MPC and remove the jumper on the format pins W8. Reset the Rotary Switches to 0,2.
7. Power the MPC back up and it will be ready to run with the restored Field Archive.



Generation 4 Water-to-Water Points Matrix (Read Left to Right Across Spread)

Point Name	Type	Number	Read/Write	Type	Register	Type	ID	NV Name	Default
	BACNet			ModBus		N2		LON	
HTD	AV	23	R/W	NA	NA	NA	NA	NA	5° F
CLD	AV	22	R/W	NA	NA	NA	NA	NA	5° F
Actual CL Setpoint	AV	1	R	NA	NA	NA	NA	NA	NA
Actual HT Setpoint	AV	2	R	NA	NA	NA	NA	NA	NA
Occupied CL SP/ Fahrenheit	AV	3	R/W	NA	NA	NA	NA	NA	53° F
Master WT/ Fahrenheit	AV	4	R/W	NA	NA	NA	NA	NA	105° F
SUBORDINATE CLD	AV	24	R/W	NA	NA	NA	NA	NA	5° F
Pulse Signal Value	AV	6	R	NA	NA	NA	NA	NA	1
Unoccupied CL SP/ Fahrenheit	AV	7	R/W	NA	NA	NA	NA	NA	73° F
SUBORDINATE HTD	AV	25	R	NA	NA	NA	NA	NA	5° F
Subordinate HT SP/ Fahrenheit	AV	9	R/W	NA	NA	NA	NA	NA	105° F
Subordinate CL SP/ Fahrenheit	AV	10	R/W	NA	NA	NA	NA	NA	53° C
HP Fault Counter	AV	11	R	NA	NA	NA	NA	NA	0
LP Fault Counter	AV	12	R	NA	NA	NA	NA	NA	0
LT1 Fault Counter	AV	13	R	NA	NA	NA	NA	NA	0
LT2 Fault Counter	AV	14	R	NA	NA	NA	NA	NA	0
CO Fault Counter	AV	15	R	NA	NA	NA	NA	NA	0
Over/Under Voltage Fault Counter	AV	16	R	NA	NA	NA	NA	NA	0
UPS Fault Counter	AV	17	R	NA	NA	NA	NA	NA	0
Swapped LT1/LT2 Fault Counter	AV	18	R	NA	NA	NA	NA	NA	0
C1 Cycle Counter	AV	19	R	NA	NA	NA	NA	NA	0
C2 Cycle Counter	AV	20	R	NA	NA	NA	NA	NA	0
Occupied HT Setpoint	AV	5	R/W	NA	NA	NA	NA	NA	105° F
Occupied HT Setpoint Celsius	AV	29	R/W	NA	NA	NA	NA	NA	40.5° C
Unoccupied HT Setpoint	AV	21	R/W	NA	NA	NA	NA	NA	85° F
Unoccupied HT Setpoint Celsius	AV	28	R/W	NA	NA	NA	NA	NA	29.4° C
HT PID	AV	38	R	NA	NA	NA	NA	NA	0
CL PID	AV	39	R	NA	NA	NA	NA	NA	0
AUX CFG	AV	26	R/W	NA	NA	NA	NA	NA	1
Zone Temp Status	AV	37	R	NA	NA	NA	NA	NA	NA
Master WT /Celsius	AV	27	R/W	NA	NA	NA	NA	NA	40.5° C
Unoccupied CL SP Celsius	AV	30	R/W	NA	NA	NA	NA	NA	22.7° C
Subordinate CL Setpoint Celsius	AV	33	R/W	NA	NA	NA	NA	NA	11.6° C

Description
Heating Differential Deadband --> Heating SP - HTD = Turnoff
Cooling Differential Deadband --> Cooling SP - HTD = Turnoff
Actual cooling setpoint based upon occupancy status, setpoint adjustment and metric conversion.
Actual heating setpoint based upon occupancy status, setpoint adjustment and metric conversion.
Network setpoint for the cooling setpoint (Fahrenheit) in Occupied Mode.
Fahrenheit network setpoint for multiple MPC's sharing the same space temperature sensor. Only for subordinate units when M/S Switch (BV:16) is "ON".
Subordinate Cooling Differential Deadband. Active only when M/S Switch (BV:16) is "ON".
Indicates the last fault code in memory on the CXM/DXM/DXM2 board. Refer to CXM/DXM/DXM2 manual for fault code descriptions.
Network setpoint for the Fahrenheit cooling setpoint in Unoccupied Mode.
Subordinate Heating Differential Deadband. Active only when M/S Switch (BV:16) is "ON".
Network Input for the actual Fahrenheit heating setpoint when used as a subordinate unit. This input is only used for subordinate units when the M/S Switch (BV:16) is "ON".
Network Input for the actual Fahrenheit cooling setpoint when used as a subordinate unit. This input is only used for subordinate units when the M/S Switch (BV:16) is "ON".
Indicates the number of High Pressure faults since startup or the last reset via Fault Count Reset (BV:22).
Indicates the number of Low Pressure faults since startup or the last reset via Fault Count Reset (BV:22).
Indicates the number of Liquid Temperature 1 faults since startup or the last reset via Fault Count Reset (BV:22).
Indicates the number of Liquid Temperature 2 faults since startup or the last reset via Fault Count Reset (BV:22).
Indicates the number of Condensate Overflow faults since startup or the last reset via Fault Count Reset (BV:22).
Indicates the number of Over/Under Voltage faults since startup or the last reset via Fault Count Reset (BV:22).
Indicates the number of UPS faults since startup or the last reset via Fault Reset (BV:24).
Indicates the number of swapped LT1/LT2 faults since startup or the last reset via Fault Count Reset (BV:22).
Indicates the number of times Compressor 1 has cycled on/off more than 6 times in one hour since startup or the last reset via Fault Count Reset (BV:22).
Indicates the number of times Compressor 2 has cycled on/off more than 6 times in one hour since startup or the last reset via Fault Count Reset (BV:22).
Network Input for the Fahrenheit Occupied heating setpoint .
Network Input for the Celsius Occupied heating setpoint.
Network Input for the Fahrenheit Unoccupied heating setpoint .
Network Input for the Celsius Unoccupied heating setpoint .
Heating PID based on the setpoint and actual space temperature in percent (%).
Cooling PID based on the setpoint and actual space temperature in percent (%).
Sets configuration parameters for the AUX output Relay (W).
Network Output for Space (Room Temp)Temperature. Celsius /Fahrenheit.
Celsius Network Input for multiple WSHP sharing the same Space Sensor. This is only for Subordinate units where the M/S switch is (BV:22) "ON".
Network Input for the Celsius cooling setpoint in the Unoccupied Mode.
Network Input for the actual Celsius cooling Setpoint when used as a subordinate unit. This input is only used for subordinate units where the M/S Switch (BV:16) is "ON".



Generation 4 Water-to-Water Points Matrix (Read Left to Right Across Spread)

Point Name	Type	Number	Read/Write	Type	Register	Type	ID	NV Name	Default
	BACNet			ModBus		N2		LON	
Subordinate HT Setpoint Celsius	AV	32	R/W	NA	NA	NA	NA	NA	40.5° C
Occupied CL SP Celsius	AV	31	R/W	NA	NA	NA	NA	NA	11.6° C
RV Status	BV	13	R	NA	NA	NA	NA	NA	NA
Work Schedule	BV	14	R/W	NA	NA	NA	NA	NA	NA
UPS Signal	BV	21	R	NA	NA	NA	NA	NA	NA
M/S Switch	BV	16	R/W	NA	NA	NA	NA	NA	OFF
C1 Runtime Alarm	BV	17	R	NA	NA	NA	NA	NA	NA
C2 Runtime Alarm	BV	18	R	NA	NA	NA	NA	NA	NA
C1 Cycle Reset	BV	19	R/W	NA	NA	NA	NA	NA	OFF
C2 Cycle Reset	BV	20	R/W	NA	NA	NA	NA	NA	OFF
Lockout Alarm	BV	21	R	NA	NA	NA	NA	NA	NA
C1 Cycle Alarm	BV	23	R	NA	NA	NA	NA	NA	NA
C2 Cycle Alarm	BV	24	R	NA	NA	NA	NA	NA	NA
AUX Status	BV	31	R	NA	NA	NA	NA	NA	NA
RV Manual	BV	25	R/W	NA	NA	NA	NA	NA	OFF
C1 Manual	BV	26	R/W	NA	NA	NA	NA	NA	OFF
C2 Manual	BV	27	R/W	NA	NA	NA	NA	NA	OFF
AUX Manual	BV	32	R/W	NA	NA	NA	NA	NA	OFF
Test Mode	BV	29	R/W	NA	NA	NA	NA	NA	OFF
Test Mode Alarm	BV	30	R	NA	NA	NA	NA	NA	NA
Metric	BV	33	R/W	NA	NA	NA	NA	NA	OFF
LWT Load Status	AV	34		NA	NA	NA	NA	NA	NA
EWT Load Status	AV	35		NA	NA	NA	NA	NA	NA
MC Switch	BV	7		NA	NA	NA	NA	NA	OFF
LWT Source Status	AV	36		NA	NA	NA	NA	NA	NA
Application Type	AV	99	R	NA	NA	NA	NA	NA	NA
Alarm State	BV	1	R	NA	NA	NA	NA	NA	NA
C1 Reset	BV	2	R/W	NA	NA	NA	NA	NA	OFF
C1 Status	BV	3	R	NA	NA	NA	NA	NA	NA
System Reset	BV	4	R/W	NA	NA	NA	NA	NA	OFF
C2 Reset	BV	5	R/W	NA	NA	NA	NA	NA	OFF
C2 Status	BV	6	R	NA	NA	NA	NA	NA	NA
Emergency Shutdown	BV	8	R/W	NA	NA	NA	NA	NA	OFF
HC Mode	BV	9		NA	NA	NA	NA	NA	OFF
CC Mode	BV	10		NA	NA	NA	NA	NA	OFF
Occupied Status	BV	11	R	NA	NA	NA	NA	NA	NA
Occupied Mode	BV	12	R/W	NA	NA	NA	NA	NA	ON

Description
Network Input for the actual Celsius Heating Setpoint when used as a subordinate unit. This input is only used for subordinate units where the M/S Switch (BV:22) is "ON".
Network Input for the Celsius cooling setpoint in the Occupied Mode.
Indicates the Reversing Valve Status (ON/ OFF).
Reads schedule from WEBCTRL and informs controls whether they are in Occupied or Unoccupied Mode.
Indicates if the UPS Mode is ON/OFF. Refer to CXM/DXM/DXM2 manual for UPS definition.
Master/Subordinate network input to enable the use of Master ZT. Master unit is defined as one WSHP per sensor and the value is "OFF". Subordinate is defined as a unit that shares a sensor with Master unit and the value is "ON".
Indicates that the number of operational hours for C1 has exceeded 5000. Reset via C1 Reset (BV:2).
Indicates that the number of operational hours for C2 has exceeded 5000. Reset via C2 Reset (BV:5).
Network Input to reset the C1 Cycle Counter (AV:19) back to zero
Network Input to reset the C2 Cycle Counter (AV:20) back to zero
Indicates the CXM/DXM/DXM2 is in Lockout Mode.
Indicated the Compressor C1 has cycled ON/OFF more than 5 times within an hour.
Indicated the Compressor C2 has cycled ON/OFF more than 5 times within an hour.
Indicates the AUX output (W) is OFF/ON.
Manual Switch to turn Reversing Valve (OFF/ ON). Only works while in Test Mode.
Manual Switch to turn Compressor C1 (OFF/ ON). Only works while in Test Mode.
Manual Switch to turn Compressor C2 (OFF/ ON). Only works while in Test Mode.
Manual Switch to turn AUX output (W) (OFF/ ON). Only works while in Test Mode.
Network Input used to bypass normal operations and operate the unit manually. Maximum on-time for Test Mode is 60 minutes.
Indicates the unit is still in Test Mode after the test mode timer has expired.
Network input used to define inputs and outputs. Celsius- ON / Fahrenheit -Off.
Leaving Water Temperature of the Load Coil
Entering Water Temperature of the Load Coil
Mode Control: ON for Cooling, OFF for Heating
Leaving Water Temperature of the Source Coil
Factory Use Only.
"ON" indicates a lockout condition exists, Off indicates normal operation.
Network Input used to reset the C1 Runtime Alarm (BV:17) once the event is triggered
Indicates if Compressor 1 is "ON" or "OFF".
Network Input used to reset the unit from lockout mode. Must turn it "ON" then turn it "OFF", not momentary.
Network Input used to reset the C2 Runtime Alarm (BV:18) once the event is triggered
Indicates if Compressor 2 is "ON" or "OFF".
Network Input for Emergency Shutdown. When engaged, Y1,Y2,G & W output relays turn "OFF".
Heating Control: OFF (EWT), ON (LWT)
Cooling Control: OFF (EWT), ON (LWT)
Indicates whether the WSHP is in Occupied "ON" or Unoccupied "OFF" Mode.
Network Input to put WSHP in Unoccupied Mode "OFF" or Occupied Mode "ON". Can be used instead of Work Schedule.



Generation 4 Water-to-Water Points Matrix (Read Left to Right Across Spread)

Point Name	Type	Number	Read/Write	Type	Register	Type	ID	NV Name	Default
	BACNet			ModBus		N2		LON	
C1 Override	BV	61	R/W	NA	NA	NA	NA	NA	OFF
C2 Override	BV	63	R/W	NA	NA	NA	NA	NA	OFF
RV Override	BV	60	R/W	NA	NA	NA	NA	NA	OFF
Multi-State Enable	BV	62	R/W	NA	NA	NA	NA	NA	OFF
Load Balance Mode	AV	59	RW	NA	NA	NA	NA	NA	2
Compressor Swap time	AV	60	R	NA	NA	NA	NA	NA	OFF
Archive Enable	BV	70	R/W	NA	NA	NA	NA	NA	OFF

Description
Used to override C1 output when multi-stage enable (BV:62) is "ON"
Used to override C2 output when multi-stage enable (BV:62) is "ON"
Used to override RV output when multi-stage enable (BV:62) is "ON"
When "ON" allows network control of C1, C2 and RV
Network Input used to select how the compressors are sequenced to balance compressor runtime.
Reboots swap time when (AV:59) is set to 4. Not editable and set to 24 hours.
Network Input used to archive current program. Standard feature in Gen 7 water-to-air controllers.

MPC Wall Sensors

ASW sensors are wall-mounted temperature sensors for use with the MPC controller on Water-to-Air units. The ASW is available in 3 different models to allow for application flexibility. Features such as room temperature sensing, digital LCD readout, set point adjustment, override push button, heat pump reset, lockout recognition, fault type, LED indicator, cosmetics and occupancy status can be supplied by the different types of ASW wall sensors. The ASW wall mounted sensors are low profile, which provides a distinguished look for building architects and engineers.

The three different types of ASW wall sensors feature easy to use analog to digital connections on the MPC. With only 4 to 5 wire connections, the field technician can easily troubleshoot the ASW to determine if it is operating properly.

The ASW 018 displays zone temperature, heating setpoint, cooling set point. And if so equipped will display sensed values of humidity and CO2.

Room temperature is measured using a 10k thermistor and can be indicated on an easy to read LCD display (with display only wall sensor). The set point adjust is a slide potentiometer which provides an analog output and is available with a Warm/Cool legend imprinted on the unit's base. The override is a momentary, normally open, push contact.

ASW wall sensors are suitable for direct-wall mount or electrical box mounting. Terminations are easily made at the screw terminal block located on the wall sensor back plate.

ASW 016, 017, 018 Sensors for MPC



ASW 016



ASW 017



ASW 018

Below is a cross reference chart of the new and old part numbers:

Part	System	Display
ASW016STC	Sensor Only	None
ASW016HUC	Std Sensor w/ Humidity	None
ASW017STC	Sensor w/Setpoint Adjustment & Override	Occupancy status LED & fault indication
ASW017HUC	Sensor w/Setpoint Adjustment, Override, & Humidity	Occupancy status LED & fault indication
ASW018STC	Digital Display Sensor w/Setpoint Adjustment, Override	Digital
ASW018HUC	Digital Display Sensor w/Setpoint Adjustment, Override with Humidity	Digital
ASW018COC	Digital Display Sensor w/Setpoint Adjustment, Override & CO2	Digital

ASW 016, 017, 018 Sensors for MPC

Specifications

Sensing Element Accuracy

Temperature	Temperature with any Option: (excluding Humidity) -4° to 122° F (-20° C to 50° C) ±0.35° F (0.2° C)	Temperature with Humidity and any Option 50° F to 104° F (10° C to 40° C) ±0.5° F (0.3° C)
Humidity	20% to 80% ±2% typical	
CO₂	400 to 1250 PPM ±30PPM or +/-3% (greater of two) 1250 to 2000 PPM ±5% of reading plus 30 PPM	
Power Requirements Sensor Type Power Required	Temperature Only: All Models 12 Vdc @ 8 mA Temperature with Humidity Temp with CO ₂ , or Temp/ CO ₂ /Humidity All Models 12 Vdc @ 15 mA (idle) to 190 mA (CO ₂ measurement cycle)	
Power Supply	A controller supplies the RNet sensor network with 12 Vdc @ 210 mA. Additional power may be required. See sensor power requirements above.	
Communication	115 kbps RNet connection between sensor(s) and controller 15 sensors max per RNet network; 5 sensors max per control program	
Local Access Port	For connecting a laptop computer to the local equipment or WebCTRL® network for maintenance and commissioning	
Environmental Operating Range	32° to 122° F (0° - 50° C), 10% to 90% relative humidity, non-condensing	
Mounting Dimensions	Standard 4"x 2" electrical box using provided 6/32" x 1/2" mounting screws	
Overall Dimensions	Width: 2.75" (6.99 cm) Height: 4.75" (12.07 cm) Depth: 13/16" (2.01 cm)	

ASW 006, 022, 008 Wall Sensors (LStat Sensors)



ASW006STC

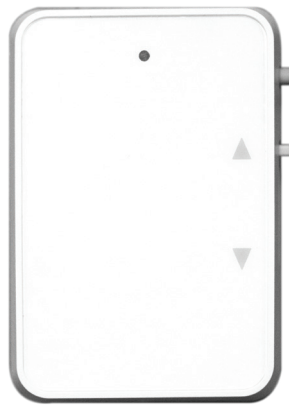

ASW022STC



ASW008STC

LStat Wall Sensors

The three different types of LStat ASW wall sensors feature easy to use analog to digital connections on the MPC. With only 4 to 5 wire connections, the field technician can easily troubleshoot to the ASW to determine if it is operating properly.

Room temperature is measured using a 10k thermistor and can be indicated on an easy to read LCD display (with display only wall sensor).

The set point adjust is a slide potentiometer which provides an analog output and is available with a warm/cool legend imprinted on the unit's base. The override is a momentary, normally open, push contact.

ASW wall sensors are suitable for direct-wall mount or electrical box mounting. Terminations are easily made at the screw terminal block located on the wall sensor back plate.

Table 9:

Model	Description	Display
ASW006STC	Sensor only	None
ASW022STC	Sensor with setpoint adjustment and override	LED for occupancy status and fault indication
ASW008STC	Sensor with setpoint adjustment and override	LED for occupancy status and fault indication, digital LCD display

ASW 016, 017, 018 Wall Sensors (RNet Sensors)

To wire and mount an ASW 016-018 Sensor

PREREQUISITE: The RNet cable is wired to the controller. The shield wire and the ground wire should be inserted into the controller's GND terminal.

1. Turn off the controller's power.
2. Pull the backplate off the RNet Sensor. You may need to turn the set screw in the bottom of the sensor clockwise until you can remove the backplate.
3. Pull the RNet communication cable through the large rectangle in the backplate.

Figure 20:

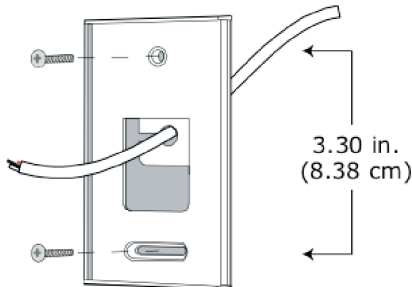

4. Use 2 screws to mount the backplate to the wall or outlet box.
5. Partially cut, then bend and pull off the outer jacket of the RNet cable(s). Do not nick the inner insulation.

Figure 21:

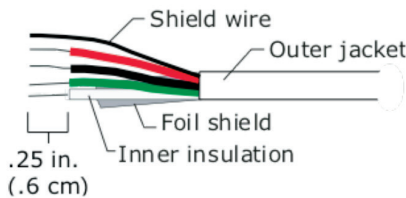

6. Strip about .25 inch (.6 cm) of the inner insulation from each wire.
7. If wiring 1 cable to the RNet Sensor, cut the shield wire off at the outer jacket, then wrap the cable with tape at the outer jacket to cover the end of the shield wire. If wiring 2 cables in a daisy-chain configuration, twist together the shield wires, then wrap the shield wires with tape.

CAUTION: Allow no more than .06 inch (1.5 mm) bare communication wire to protrude. If bare communication wire contacts the cable's foil shield, shield wire, or a metal surface other than the terminal block, the sensor may not communicate correctly.

8. Insert the other 4 wires into the RNet Sensor's screw terminal connector. If wiring 2 cables, insert like colored wires into each terminal.

Figure 22:

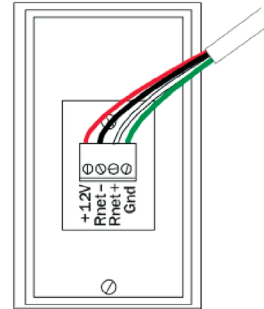

It is recommended that you use the following RNet wiring scheme:

Connect this wire...	To this terminal...
Red	+12V
Black	RNet-
White	RNet+
Green	Gnd

9. Attach the sensor's cover and circuit board to the mounted backplate, inserting the top first.
10. Turn the set screw one full turn counterclockwise so that the cover cannot be removed.
11. Turn on the controller's power.

To address an ASW 016-018 Sensor

Each ASW 016-018 Sensor on an RNet must have a unique address, but addresses do not have to be sequential. Use the DIP switches on the back of the RNet Sensor to set an address from 0 to 14 (0 is factory default) Each DIP switch has the value shown in the figure below. Turn on as many DIP switches as you need so that their total value equals the address.

Figure 23:

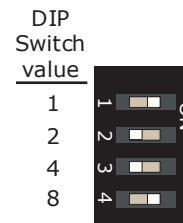

EXAMPLE: DIP switches 1 and 4 above are on. Their values (1 + 8) total 9, so the sensor's address is 9.

ASW LED indicator on the wall sensor turns "ON" during Occupied Mode and turns 'OFF' during "Unoccupied" Mode.

ASW 016, 017, 018 Wall Sensors (RNet Sensors)

Push Button Override (if equipped)

To override the Unoccupied Mode: Press override button for 1 second. The LED indicator on the ASW wall sensor will illuminate to indicate occupied status. The controller goes into Occupied Mode for 60, 120, or 180 minutes, determined by the number of times the override button is pressed by the occupant.

To increase the override time: If override time has not expired, press the override button for additional minutes of override time. The maximum override time will always be 180 minutes.

To cancel override: Press and hold the override button for 3 seconds or more. The override time is cancelled and the ASW LED indicator will turn off. The MPC will return to Unoccupied Mode.

Reading Lockout Code at ASW Wall Sensor

If a heat pump experiences a lockout condition (for example, “high pressure” refrigeration failure), a corresponding code will be displayed at the wall sensor (providing a sensor with LED/display is used). See CXM/DXM/DXM2 Application Manual for detailed description of operation and fault types.

The Lockout Code will be displayed as long as the alarm relay on the CXM/DXM/DXM2 is closed, meaning that the CXM/DXM/DXM2 remains locked out. When the CXM/DXM/DXM2 is reset from Lockout Mode, the ASW LED/display will return to indicating “Occupied” or “Unoccupied” Mode.

Note: If the MPC Controller is connected to a dual compressor heat pump with 2 CXM controls, the wall sensor will only display the lockout information for the CXM which is connected to compressor stage 1. Lockout information from the CXM controlling the 2nd stage compressor will never be displayed. If the MPC is connected to a dual compressor heat pump with 2 DXM/DXM2 controls, the wall sensor will display the lockout fault code for either compressor stage.

Table 10: LED and Fault Indications

LED or LCD Indicator	Operation Indication
LED “ON” or “Occupied” LCD display	Occupied Mode with no heat pump faults
LED “OFF” or “Unoccupied” LCD display	Unoccupied Mode with no heat pump faults
2 flashes (E2 display)	High pressure lockout
3 flashes (E3 display)	Low pressure lockout
4 flashes (E4 display)	Water coil low temperature lockout
5 flashes (E5 display)	Air coil low temperature lockout
6 flashes (E6 display)	Condensate overflow lockout
7 flashes (E7 display)	Over / Under voltage shutdown
8 flashes (E8 display)	UPS (Unit Performance Sentinel) warning
9 flashes (E9 display)	Thermistor swapped position

Resetting Lockout at ASW wall sensor

The “Override” or “Manual On” button can be used to reset a heat pump lockout at the wall sensor.

- The LED or indicator will indicate a lockout code.
- Push the “Override” or “Manual On” button for 1 second.
- The MPC will interpret the button press as a manual reset and the MPC will reset the heat pump.
- The MPC will return the heat pump to normal operating mode.

Note: If the MPC was in Unoccupied Mode before the heat pump lockout, and the heat pump is reset via the “Override”/“Manual On” button, the MPC will reset AND will now have 60 minutes of override time.

Setpoint Adjust

The setpoint adjust is a slide pot which provides an analog output and is available with a Warm/Cool legend imprinted on the unit’s base. The user can adjust the setpoint to the minimum user set value (default 5° less than scheduled setpoint) by sliding the adjust to the “cool” position. The user can adjust the setpoint to the maximum user set value (default 5° more than scheduled setpoint) by sliding the adjust to the “heat” position. The setpoint adjust operation can be modified by changing the function block programming within the MPC (See Water-to-Air Sequence of Operation).

Fail Safe Mode

If the connections between the MPC and ASW wall sensor are interrupted or disconnected, the MPC will force the digital outputs to the “Off” state. When the connections to the wall sensor thermistor are restored, the MPC resumes normal control.

Android App Installation

This section covers the installation and setup of the Android Application from OEMCntl that allows an Android capable tablet/phone to replace the physical Equipment Touch module. The tablet/ phone must have an available USB connection. Most all phones will require a micro or sub micro USB to standard USB adapter. (See Figure 23.)

Required Components:

Tablet Model Used: RCA Galileo PRO
Operating System: Android 6.0 (Marshmallow).

USB Cable: AAPPLDRKIT KIT, SW, MPC, APPLDR/ VBVIEW/ EQ TOUCH

App: Equipment Touch(OEM), Available at Google Play store. WWW.play.GOOGLE.com

Vendor: OEMCntl, Cost: \$29.00

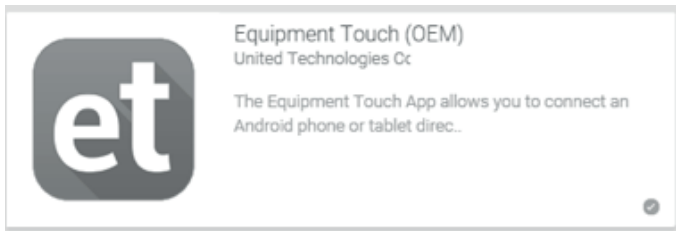

6. At this point you can use the Tablet or Phone to set up and monitor the MPC just as if it had an Equipment Touch Screen attached.
7. One final note: Equipment Touch has built in Temperature and Humidity Sensors allowing it to function as a Wall Sensor. The Tablet/ Phone does not so it cannot function as a wall sensor.

Figure 24: USB Dongle and Cable



Installation

1. Navigate a browser to **play.GOOGLE.com (Google Store)** and download the Android Equipment Touch application on to the tablet or phone to be used in this application. Note: Each individual device to be used must have a separate license. As of July 22, 2020, the license cost is \$ 29.00 per device.
2. When the Equipment Touch Application is installed, connect the USB dongle included in the AAPPLDRKIT (See Figure 24.)to the Tablet or Phone (As stated before, the phone may require a Micro USB to USB adapter. See Figure 25.)
3. Connect a cable from the MPC USB port to the Dongle.
4. Launch the Equipment Touch Application.
5. When the app starts it will bring up a device list. Click on the USB Device. The App will load and bring up the Main Equipment Touch menu.

Figure 25: Micro USB to USB Adapter



MPC Technical FAQs

Q. Why does the set point go to 45°F in Heating Mode 5 minutes after unit startup?

- A. This is the default condition if there is not a valid resistance between the GND and SW terminals on the MPC. If this occurs, check the MPC for loose strands of copper or a missed wire.

Q. Why is my compressor, fan or RV not energizing?

- A. Wait 5 minutes after startup. If the unit has not started after 5 minutes, check the output LEDs on the MPC. If they are OFF, make sure that the unit is not in Unoccupied Mode. If any of them are ON and you still have no activity verify that you have 'R' wired to the 'R' on the unit controller. If not, jump 24Vac to 'Y', 'O', or 'G' and check if they are energized. If not, contact tech support.

Q. I replaced a CXM/DXM/DXM2 control board and when I applied power the MPC board was destroyed, Why?

- A. Jumper JW1 on the CXM/DXM/DXM2 control is not cut and 24V power was incorrectly applied to the MPC. This is not repairable, the MPC must be replaced.

Q. Why does the alarm relay indicate the unit is in an alarm state on the BMS but not at the CXM?

- A. The jumper IN1 on the MPC is set to 0-5Vdc instead of dry. Jump back to dry contact to resolve this issue.

Q. Can I use another sensor besides the ASW?

- A. A 10k type 2 temperature thermistor can be connected to the LStat terminals. Connect between temp and ground. Also, connect a 2.4k 1% resistor between SW and ground. Thermostats will not work with the MPC.

Q. My unit is not communicating on the network? Why?

- A. Verify that all baud rates, protocol and communication selections are correct. Then verify that the Tx and/or Rx LEDs are flickering. Make sure that the addressing is correct, unique and not sharing a same address as another controller.

Q. Why is my temperature reading different than the actual temperature?

- A. Make sure that the gain jumper is set in the OFF position. The jumper puts the temperature on a sharper curve meant for water to water applications. Also, make sure that the sensor is in a reasonable location and not right in front of the airway of the unit.

Q. Why is my RNet sensor all buggy?

- A. Make sure that you move the jumper from LStat to RNet.

Q. Can a thermostat be used with MPC?

- A. No, ASW... sensors must be used.

Q. What type/size of wire do the ASW... sensors require?

- A. Typical thermostat cable is suitable 22 to 18 gauge. ASW 008 sensor requires 5-conductor all others require 4-conductor.

Q. Is temperature averaging available?

- A. Yes using the RNet sensors. Up to five sensors may be daisy chained. One ASW 018 and up to four ASW 016 can be connected. Wire to ASW 018 first and then to the ASW 016's. Address each ASW 016 with a unique address.

Equipment Touch Manual (Water-to-Air) **Generation 7**

Screen Descriptions

All application specific user screens are covered in this document. There are built in factory screens that are not covered in this document. For information on those screens, please refer to the Equipment Touch Installation and Setup Guide available from the OEMCtrl web portal.

Home Screen

The home screen allows access to all setup and status screens both application specific and factory screens.

The Home screen contains the following buttons allowing access to the following Screens:

1. **Alarm**- For monitoring and clearing all active alarms.
2. **Archive**- Used to archive the current downloaded MPC file.
3. **MPC Setup/Status**- Navigates to the screen allowing access to all user setup/status screens.
4. **Maintenance**- Navigates to the Monitor Screen used for observing MPC operation.
5. **System**- Used to access MPC setup screens.
6. **About**- Version Information.
7. **Reserved**- Future use.

Figure 26: Home Screen



There are three Icons that are present on every screen, Home, Back and Information. Clicking the Home Screen Icon will return the user to the screen which is the top of the Screen Hierarchy. The back arrow Icon is used to go up one screen in the hierarchy. The Information Icon displays any active alarms or other pertinent system information

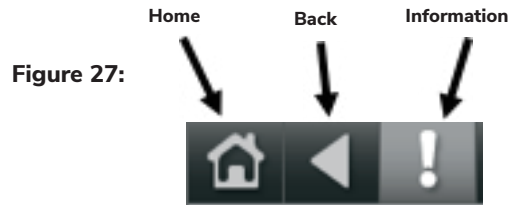

Figure 27:

Equipment Touch Manual - Screen Descriptions (Water-to-Air) **Generation 7**

Maintenance Screen

The Maintenance Screen is used to monitor normal operation of the MPC unit and contains various status points. Using the **Home Icon** or **Home Button** will return the user to the Home Screen. For information on the Maintenance Screen, the **Help** Button will provide help on the meaning and use of the Icons used in the Screen.

Figure 28:

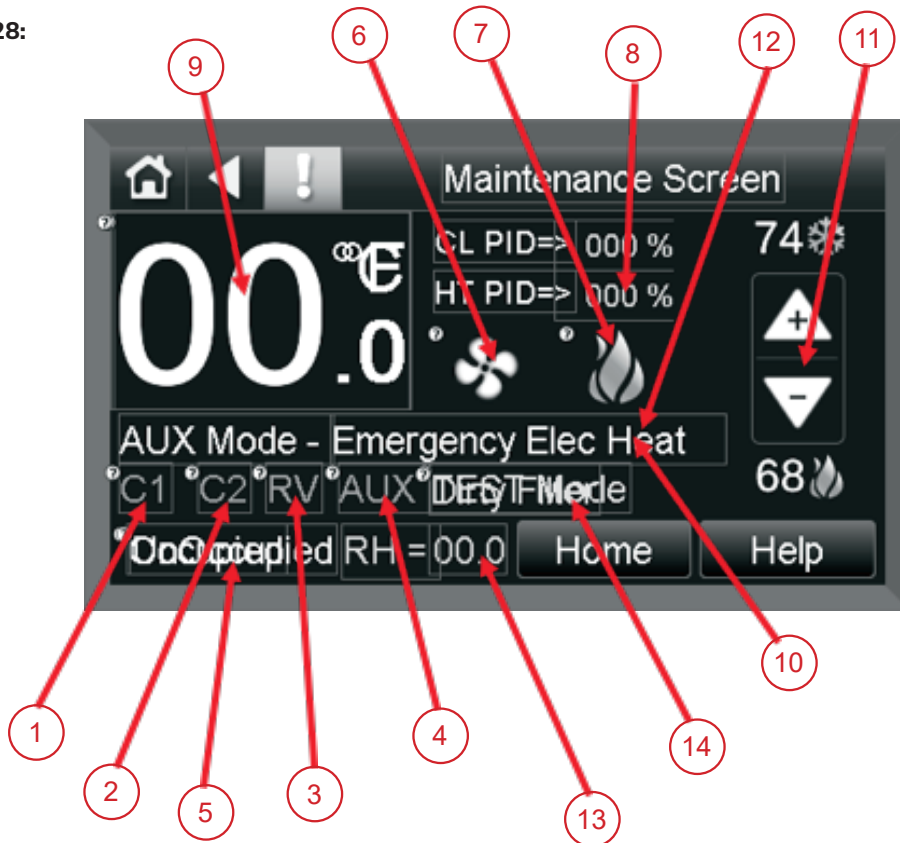

1. Compressor Stage 1 "ON" when → C1 icon is visible.
2. Compressor Stage 2 "ON" when → C2 icon is visible.
3. Reversing Valve "ON" when → RV icon is visible.
4. Auxiliary Output 2 "ON" when → AUX icon is visible.
5. Occupancy Status **<Unoccupied or Occupied>**
6. Fan Output "ON" when → Fan icon is visible.
7. Heating PID %
8. Cooling PID %
9. Zone Temperature
10. AUX Mode setting
11. Heating/cooling setpoints
12. Heat/cool Icons displayed when greater than 50% demand.
13. Relative Humidity Display
14. Test Mode/Dirty Air Filter Mode

Equipment Touch Screen Descriptions (Water-to-Air) **Generation 7**

MPC Setup/Status Screen

From this screen, you can access all control and status checking functions within the MPC GEN 7 Controller.

Figure 29:

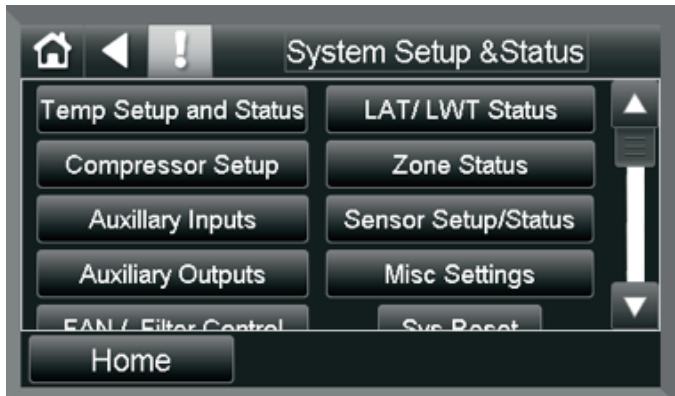

1. **Temp Setup and Status**- Provides user access to Temp Units and Temp Setpoints screen for setting temperature units and temperature setpoints respectively. There are no control or status points on this screen.

Figure 30:



2. **Compressor Setup** - Provides user access to all control points and status points related to compressor operation. All control points are on the main screen while status points are contained in a sub menu called Status.
3. **Auxiliary Inputs** – Provides user access to the control points and status of the auxiliary inputs.
4. **Auxiliary Outputs** - Provides user access to the control points and status of the auxiliary outputs. **(Control/ Status)**.
5. **Fan/ Filter Control** - Provides access to all control points and status of the fan or Dirty Filter alarm function
6. **CO2/ VOC/Humidity** - Provides access to the control points and status of the CO2/VOC and Humidity sensing functions.
7. **Occupancy** - Provides access to the control points related to setting and overriding Occupancy.
8. **Heat/Cool Control** - Provides access to the control points and status of the heating and cooling functions.
9. **MPC Alarms** - Provides access to the MPC Alarm Status Screen **(Status Only)**.
10. **MPC Faults** - Provides access to the MPC Fault Status Screen **(Status Only)**.
11. **LAT/ LWT Status** - Provides access to I/O related to LWT/ LAT points **(Status Only)**.
12. **Zone Status** - Provides access to Zone Temperature Status and PID values.
13. **Sensor Setup/ Status** - Provides access to RNet Sensor Setup sub-screen and the RNet Sensor Active Screen.
14. **MPC Monitor Screen** - Quick view of the system status.
15. **System Reset** - takes the user to Mode Settings screen that gives the user the option to reset the MPC to its default settings.
16. **Mode Settings** - Provides the user the option to enable certain modes and to reset the MPC to its default settings.

Equipment Touch Screen Descriptions (Water-to-Air) **Generation 7**

Temperature Units Screen

Password Protected

User can set the temperature units (Fahrenheit or Celsius) via the (BV:39) check box and view the current temperature mode selected. Checking (BV:39) selects Metric (Celsius) Mode. The Help button takes the user to a Help screen that explains the settings available in this screen.

Figure 31:

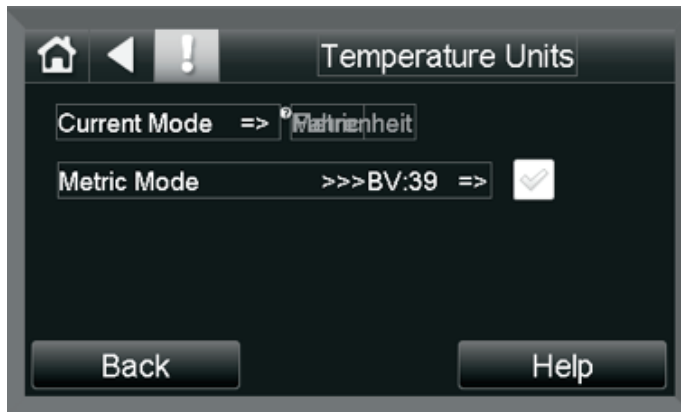

1. **Current Mode** - displays the current Temperature Mode as Celsius or Fahrenheit.
2. **Metric Mode** - Selection point (BV:39), Check to put unit in Metric or Celsius Mode.

Temperature Setpoints Screen

Password Protected

Gives the user access to all Temperature Related Setpoints available in this screen. It also provides access to the Manual Setpoints screen via the Manual SP button.

Figure 32:

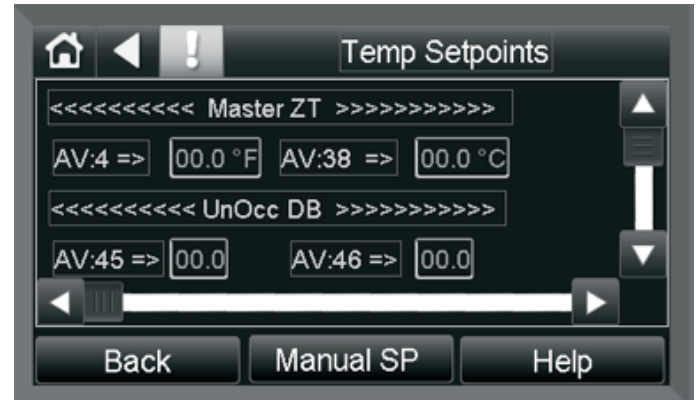

1. **Master ZT** – Sets the Master Zone Temperature setpoints (F° C°).
2. **UnOcc DB** - Sets the Unoccupied Dead Band setpoints (F° C°).
3. **Occ DB** – Sets the Occupied Dead Band Setpoints
4. **UnOcc HTSP** - Sets the Unoccupied Heating Setpoints (F° C°).
5. **Occ HTSP** – Sets the Occupied Heating Setpoints (F° C°).
6. **UnOcc CLSP** - Sets the Unoccupied Cooling Setpoints (F° C°).
7. **Occ CLSP** – Sets the Occupied Cooling Setpoints (F° C°).
8. **Subordinate HTSP** – Sets the Subordinate Heating Setpoints (F° C°).
9. **Subordinate CLSP** – Sets the Subordinate Cooling Setpoints (F° C°).

Equipment Touch Screen Descriptions (Water-to-Air) **Generation 7**

Manual Setpoint Adjustment

Password Protected

Sets the maximum number of degrees the user can adjust the zone's setpoints from a zone sensor. The adjustment range is defined as +/- the value of Manual SP Adjust. Example: If Manual SP Adjust is = 2 the adjustment range would be +/- 2 degrees from the Master Zone Temperature (72°) or from 70° to 74°.

Figure 33:



1. **Manual Setpoint Adjust (AV:37)** - Sets the Adjustment span when in Fahrenheit Mode.
2. **Manual Setpoint Adjust (AV:44)** - Sets the Adjustment span when in Celsius Mode.

Compressor Setup

Password Protected

The Compressor Setup screen contains all control points listed below and a button for accessing the Status screen and the Help Screen.

Figure 34:

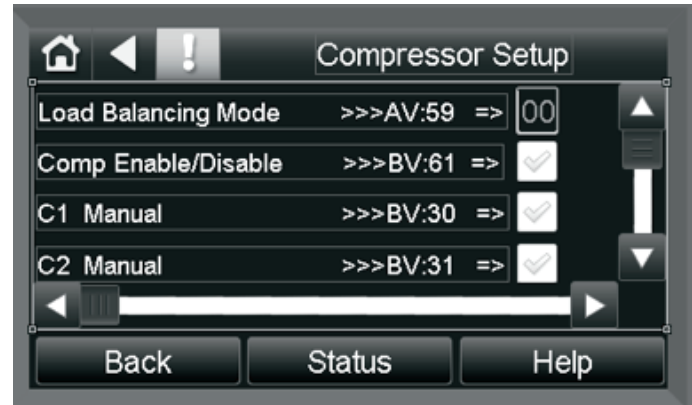

1. **Load Balancing Mode** - Defines the mode of operation for the runtime balancing of a 2 Compressor application. The modes are set by entering the following in AV:59
 - a. **AV:59 = 01**- Runtime Comparison Mode - The compressor with the least runtime becomes the stage 1 compressor while the high time compressor becomes the stage 2 compressor.
 - b. **AV:59 = 02** - Manual - C1 is Stage 1, C2 is Stage 2.
 - c. **AV:59 = 03** - Manual - C2 is Stage 1 and C1 is Stage 2.
 - d. **AV:59 = 04** - Time Toggle- C1 and C2 swap stages every 12 hours dependent on demand.
2. **Compressor Enable/Disable** - This setting either enables or disables both C1/ C2 Compressor Outputs.
3. **Compressor Runtime Resets** - This resets the C1/C2 runtime counters back to zero. The compressor alarms are set to trigger at 5000 hours.
4. **Compressor Cycle Alarm Resets** - Resets the Alarm that gets triggered when there are more than 6 compressor demand cycles within any one hour period of time.
5. **Compressor Manual ON controls** - These points are used to manually turn on the C1 or C2 outputs. Unit must be in Test Mode for these to function.

Equipment Touch Screen Descriptions (Water-to-Air) **Generation 7**

Compressor Status Screen

Password Protected

This screen allows the user to monitor all compressor related status points real time. The points contained are listed below with a short description of their individual function.

Figure 35:

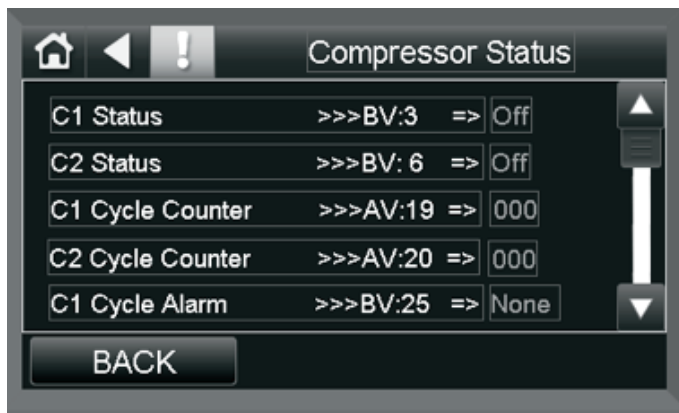

1. **C1 Status** - Reports the state of the C1 Compressor Output as either ON or OFF.
2. **C2 Status** - Reports the state of the C2 Compressor Output as either ON or OFF.
3. **C1 Cycle Counter** - Records the number of C1 Cycle Alarms that have occurred.
4. **C2 Cycle Counter** - Records the number of C2 Cycle Alarms that have occurred.
5. **C1 Cycle Alarm** - Reports the presence of a C1 Cycle Alarm. No alarm appears as **<None>**.
6. **C2 Cycle Alarm** - Reports the presence of a C2 Cycle Alarm. No alarm appears as **<None>**.
7. **C1 Runtime Alarm** - Reports the presence of a C1 Compressor runtime alarm. No alarm appears as **<None>**.
8. **C2 Runtime Alarm** - Reports the presence of a C2 Compressor runtime alarm. No alarm appears as **<None>**.

Aux Input Screen

Password Protected

This screen allows user to set Aux Input configuration and monitor the status of Aux Inputs and Outputs. It contains no sub screens other than the Help screen.

Figure 36:

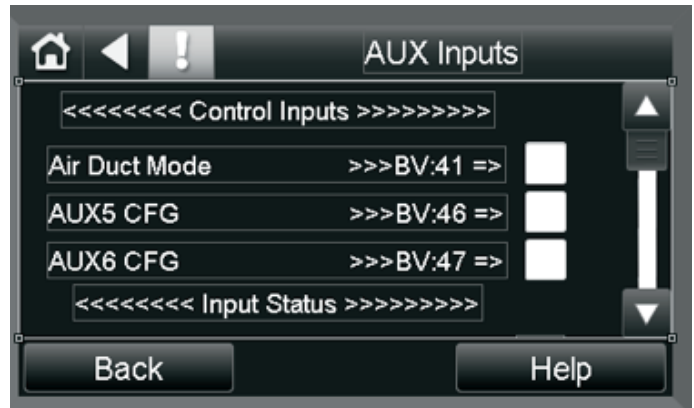

1. **AUX5 CFG** - Determines if AUX5 is set for Temperature or Dry Contact Input. *Setting:* Checking the box sets it for Temp, unchecked is for Dry Contact.
2. **AUX6 CFG** - Determines if AUX6 is set for Temperature or Dry Contact Input. *Setting:* Checking the box sets it for Temp, unchecked is for Dry Contact.
3. **AUX1** - Dry Contact Input. This status point returns the current value of AUX1.
4. **AUX2** - Dry Contact Input. This status point returns the current value of AUX2
5. **AUX3** - Dry Contact Input. This status point returns the current value of AUX3.
6. **AUX4** - Dry Contact Input. This status point returns the current value of AUX4.
7. **AUX3 Temp** - Binary (Temp) Input- This status point returns the current value of AUX3.
8. **AUX4 Temp** - Binary (Temp) Input- This status point returns the current value of AUX4.
9. **AUX5** - Aux 5 Binary Output, Configured by AUX5 CFG.
10. **AUX6** - Aux 6 Binary Output, Configured by AUX6 CFG.
11. **AUX5 Temp** - Aux 5 Analog Output. Configured by AUX5 CFG.
12. **AUX6 Temp** - Aux 6 Analog Output, Configured by AUX6 CFG.

Equipment Touch Screen Descriptions (Water-to-Air) **Generation 7**

Aux Outputs Screen

Password Protected

This screen allows user to set AUX Config, AUX Manual and Aux Toggle in addition to monitoring the same via the Status sub screen.

Figure 37:



1. **AUX_CFG** - Controls the output function of the AUX output dependent on the value of AV: 31. See table to the right.
2. **AUX_Manual** - AUX Manual will turn on/ turn off the AUX output. Must be in TEST Mode for this to function.
3. **AUX_TOGGLE** - Sets the value of the AUX output while in AUX TOGGLE Mode.

Table 11:

AUX_CNTL	Function of AUX Output	Behavior
1	Emergency Electric Heat	AUX ON if PID > 90% Demand
2	Cycle with Compressor	AUX ON when Compressor (C1) ON
3	Cycle with FAN	AUX ON when FAN(SF) ON
4	Slow Opening Water Valve	AUX ON with C1 or C2 Demand Call
5	High Speed Fan	AUX ON if HMODE or CMODE < FAN Speed Trigger
6	Alarm Relay Output	AUX On anytime ALARM is True
7	Reheat ICM & DXM STD	Reheat with MPC SF, C and RV on
8	Reheat ICM & DXM REV	Reheat with MPC SF, C and RV on
9	Reheat DXM STD	Reheat with MPC SF, C and RV off
10	Reheat DXM REV	Reheat with MPC SF, C and RV off
11	AUX Toggle	AUX will assume value of BV:40
12	Relative Humidity Mode	AUX ON anytime RH Exceeds Trip Point
13	CO2 Trip Point Exceeded	AUX ON anytime CO2 Exceeds Trip Point
14	VOC Trip Point Exceeded	AUX ON anytime VOC Exceeds Trip Point
15	Full Time Electric Heat	AUX ON anytime Heating Call made.

Equipment Touch Screen Descriptions (Water-to-Air) **Generation 7**

Aux Outputs Status Screen

This screen allows user to view AUX Config, AUX Output and Electric Heat status.

Figure 38:

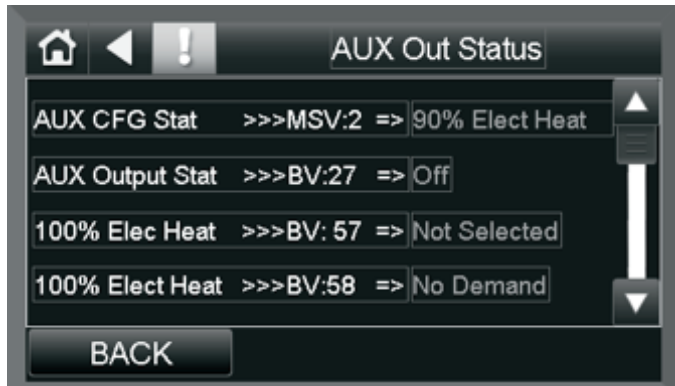

1. **AUX CFG Stat** - Reports current AUX CFG Setting.
2. **AUX Output Stat** - Reports the current state of the AUX output.
3. **100% Electric Heat** - Reports if this mode is selected or not selected.
4. **100% Electric Heat** - Reports if there is electric heat demand or no demand.

Fan/ Filter Control Screen

Password Protected

Provides access to all control points associated with controlling the fan or the Dirty Filter alarming function. Also provides access to Fan / Filter Control Status Screen.

Figure 39:

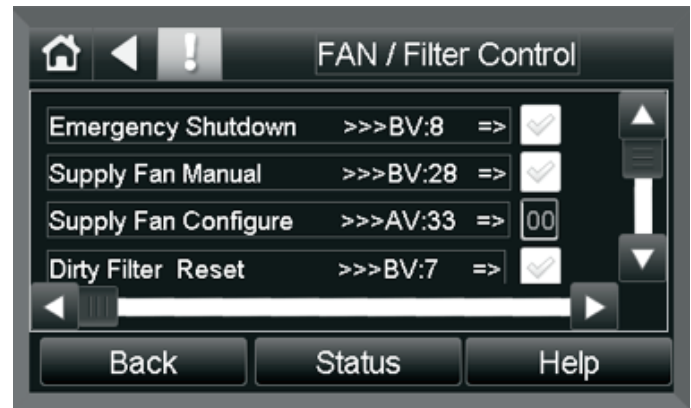

Control Points associated with this screen are described below:

1. **Emergency Shutdown** - This point shuts down the fan, compressors and all associated control logic.
2. **Supply Fan Configure** - This point is used to control the action and behavior of the supply fan.
 - 1 => ON by demand, Occupied or Unoccupied.
 - 2 => ON while Occupied and ON by demand in unoccupied hours.
 - 3 => ON all the time.
3. **Dirty Filter Reset** - Resets the Dirty Filter Timer back to Zero.
4. **Dirty Filter Interval** - Allows setting of time interval for Dirty Filter. Must be in Time Mode.
5. **Dirty Filter Sensor** - Checking this option allows (BI:8) to function as pressure input for Dirty Filter Detection.
6. **Fan Speed Enable** - Forces AUX out to ON state when in High Speed Fan Mode.
7. **Fan Speed Trigger Type** - Sets the Trigger point for the high speed fan AUX output (W) when in High Speed Fan Mode. Should be between 41% and 99%.

Equipment Touch Screen Descriptions (Water-to-Air) **Generation 7**

Fan/ Filter Control Status Screen

Provides access to the fan/ Dirty Filter Alarm Status points.

Figure 40:

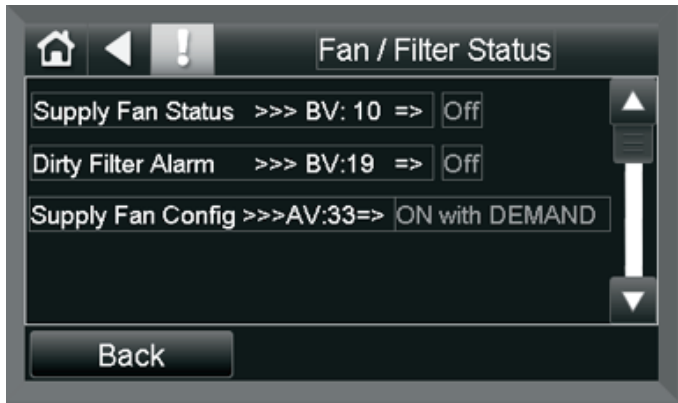

Status points associated with this screen are described below:

1. **Supply Fan Status**- Reports whether the Supply Fan is OFF or ON.
2. **Dirty Filter Alarm**- Reports whether the Dirty Filter Alarm is OFF or ON.
3. **Supply Fan Config**- Reports the Current configuration of the Supply Fan. The valid states are as follows:
 - a. ON with Demand
 - b. ON while Occupied
 - c. ON all the time

CO2/ VOC/ Humidity Control Screen

Password Protected

This screen contains all points associated with setting the trip points and access to the status sub screen for the CO2/ VOC/ humidity sensors.

Figure 41:



Control Points associated with this screen are shown below:

1. **CO2 Trip Point**- Sets the trip level of the CO2 sensor in Parts Per Million (PPM).
2. **VOC Trip Point**- Sets the trip level of the VOC sensor in Parts Per Million (PPM).
3. **Humidity Trip Point**- Sets the trip level of the RH sensor in percent Humidity (%RH). There is no alarm associated with this as exceeding the trip point is used to turn on the AUX output only when in Relative Humidity Mode.
4. **Humidity Dead Band**- Subtracts the Dead Band Value from the Setpoint Value keeping the AUX from responding until it has exceeded the setpoint by the Dead Band Value:

Example: If the setpoint is 30 % and the Dead Band is 2%, the AUX will not respond until it reaches 32% R.H. So AUX will not trip until it reaches the Setpoint + Dead Band.
5. **Humidity Occupancy**- This point controls the actuation of the AUX output in Relative Humidity Mode. When OFF the AUX output goes on when the Trip Point is exceeded and the MPC is in Occupancy Mode. When It is ON the AUX output will respond anytime the setpoint is exceeded regardless of Occupancy status.

Equipment Touch Screen Descriptions (Water-to-Air) **Generation 7**

CO2/ VOC/ Humidity Status Screen

This sub-screen of the CO2/ VOC/ Humidity Control Screen is used to access the status of the various alarms and readings of the afore mentioned sensors.

Figure 42:

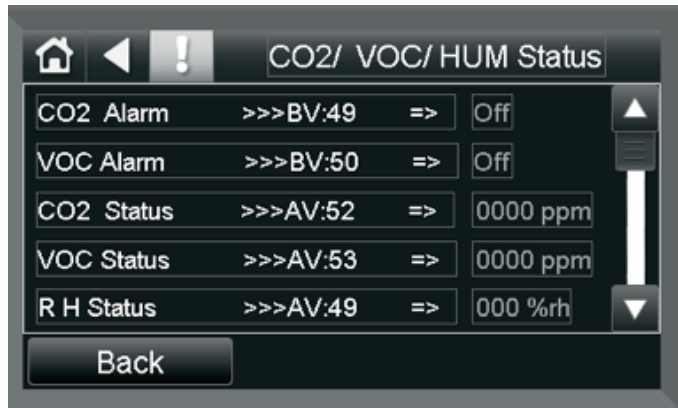

Control Points associated with this screen are shown below:

1. **CO2 Alarm**- Set the CO2 Alarm when the CO2 level exceeds the setpoint. The Alarm will extinguish when the CO2 levels drop below the setpoint.
2. **VOC Alarm**- - Set the VOC Alarm when the VO2 level exceeds the setpoint. The Alarm will extinguish when the VOC levels drop below the setpoint.
3. **CO2 Status**- Displays the actual CO2 level from the sensor in PPM.
4. **VOC Status**- Displays the VOC level from the sensor in PPM.
5. **R.H Status**- Displays the Relative Humidity from the sensor in %.

Occupancy Screen

Password Protected

Provides access to the control points related to setting and overriding occupancy. (**Control/ Status**)

Figure 43:

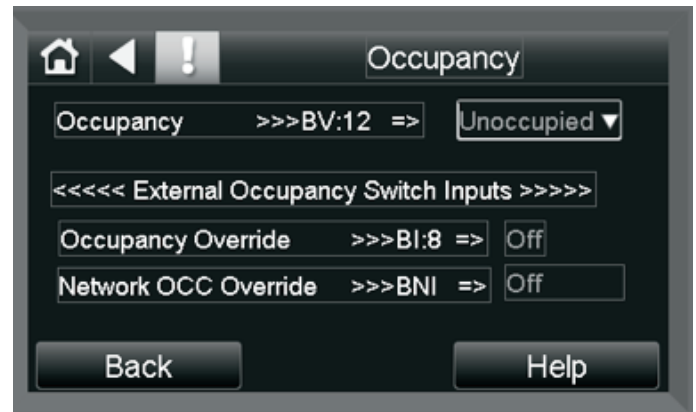

1. **Occupancy** - This point controls whether the unit is in Occupied or Unoccupied Mode. It is normally defaulted to Occupied. It can be set and overridden via the Equipment Touch or from the BMS control program (WEBCTRbn L).
2. **Occupancy Override** - is a digital input (BI:8) used to input a signal from an external motion sensor to override the occupancy. For this to function OCC/Dirty Filter Sensor (BV:59) must be set to OFF.
3. **Network OCC Override** - BNI is used via the Network to override the occupancy status of the MPC unit.

Equipment Touch Screen Descriptions (Water-to-Air) **Generation 7**

Heat/Cool Control

Password Protected

Provides access to the control points and status screen related to controlling heating and cooling function.

Figure 45:

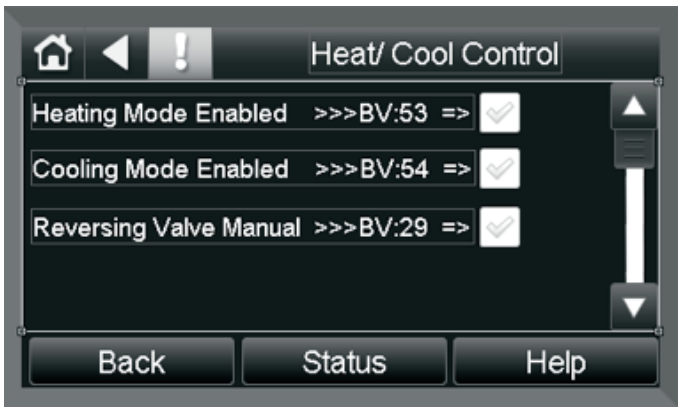

1. **Heating Mode Enabled**- When “Heating Mode” is checked, Heating Mode is enabled. The default is checked. This allows Heating Mode to be disabled when cooling only is desired.
2. **Cooling Mode Enabled**- When “Cooling Mode” is checked, Cooling Mode is enabled. The default is checked. This allows Cooling Mode to be disabled when heating only is desired.
3. **Reversing Valve Manual**- Used in conjunction with Test Mode to manually engage/disengage the reversing valve.

Heat/Cool Control Status Screen

This is a sub screen of the Heat/ Cool Control screen used to show the status of the RV, and derivatives of the PID Control Block.

Figure 46:

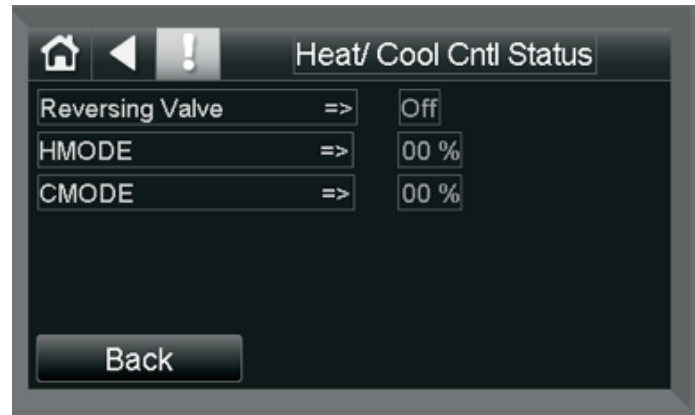

1. **Reversing Valve**- Shows the current status of the Reversing Valve.
2. **HMODE**- Conveys the status of the Heating PID output. Will read zero when in Test Mode.
3. **CMODE**- Conveys the Status of the Cooling PID output. Will read zero when in Test Mode.

Equipment Touch Screen Descriptions (Water-to-Air) **Generation 7**

MPC Alarms

Provides access to the various MPC Alarms (**Status Only**)

Figure 47:

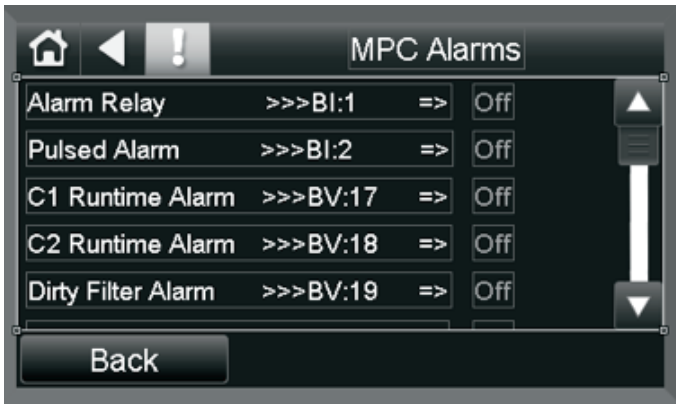

- 1. Alarm Relay**- Monitors the Alarm Relay Input BI:1 from DXM2, EXM etc.
- 2. Pulsed Alarm**- Monitors the Pulsed Alarm Input BI:2 from DXM2, EXM etc.
- 3. C1 Runtime Alarm**- Alarm set to trigger when Compressor 1 exceeds 5000 hours runtime
- 4. C2 Runtime Alarm**- Alarm set to trigger when Compressor 2 exceeds 5000 hours runtime.
- 5. Dirty Filter Alarm**- This alarm is based on accumulated time or air pressure sensor and indicates the return air filter is dirty.
- 6. Valid Sensor Alarm**- This alarm indicates that the ZS Sensor is not present. Select "Alarm Enabled" for each sensor in the system. If "Alarm Enabled" is not checked for a sensor, and that sensor is missing, an alarm will not be activated.
- 7. Lockout Alarm**- This alarm is present anytime a fault causes a lockout. This alarm will self-clear when the lockout condition is removed.
- 8. C1 Cycle Alarm**- Alarm set to trigger when Compressor 1 exceeds 6.5 demand cycles within a 1 hour period.

- 9. C2 Cycle Alarm**- Alarm set to trigger when Compressor 2 exceeds 6.5 demand cycles within a 1 hour period.
- 10. TEST Mode Alarm**- This alarm is present when the MPC is put into Test Mode and stays in Test Mode longer than 1 hour
- 11. CO2 Alarm**- Alarm triggers when CO2 level exceeds the setpoint.
- 12. VOC Alarm**- Alarm triggers when VOC level exceeds the setpoint.

Equipment Touch Screen Descriptions (Water-to-Air) **Generation 7**

MPC Faults

This screen reports the fault count for various fault types and includes the reset function to clear those same faults. For more information on these faults, please refer to the DXM2 Software specification.

Figure 48:

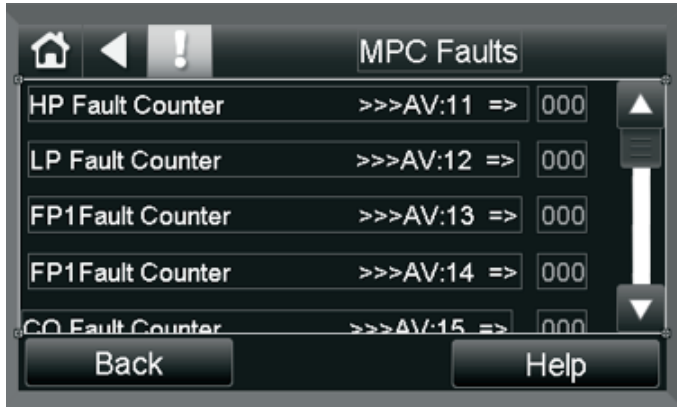

1. **HP Fault Counter**- High Pressure fault counter.
2. **LP Fault Counter**- Low Pressure fault counter.
3. **FP1 Fault Counter**- Freeze Protect 1 Fault (open or shorted).
4. **FP2 Fault Counter**- Freeze Protect 2 Fault (open or shorted).
5. **CO Fault Counter**- Condensate Overflow fault alarm.
6. **Over/Under Fault Counter**- Over/Under Voltage Fault detection alarm.
7. **UPS Fault Counter**- Unit Performance Sentinel Fault.
8. **Swapped FP1/FP2 Fault**- Indicates FP1 and FP2 are swapped or reversed.
9. **Airflow Fault Counter**- Airflow Fault
10. **Pump Fault Counter**- Pump Fault
11. **Fault**- Aggregate Fault number
12. **Pulse Signal Value**- Previous Pulse Alarms counts from external Controller.
13. **UPS Signal Enable**- Reports the status of the Unit Performance Sentinel.
14. **Valid Sensor**- Valid Sensor Detected
15. **Fault Count Reset**- Resets all Fault Counters when ON

LAT/ LWT Status

This screen reports the Leaving Air Temperature and the Leaving Water Temperature status. These points do not affect control of the MPC unit but instead are for reporting purposes for the BMS and are available via analog outputs 1 and 2.

Figure 49:

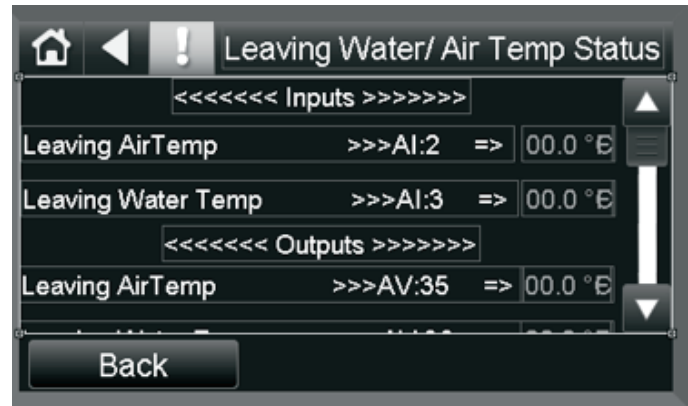

1. **Leaving Air Temp**- Reports the Leaving Air Temp when an appropriate sensor is connected to AI:2.
2. **Leaving Water Temp**- Reports the Leaving Water Temp when an appropriate sensor is connected to AI:3
3. **Leaving Air Temp**- Network output representing Leaving Air Temp. It will be in F° or C° depending on the status of the "Metric" Control Point (BV:39).
4. **Leaving Water Temp**- Network output representing Leaving Water Temp. It will be in F° or C° depending on the status of the "Metric" Control Point (BV:39).
5. **RS: LAT**- Leaving Air Temperature analog output
6. **LRS: LWT**- Leaving Water Temperature analog output.

Equipment Touch Screen Descriptions (Water-to-Air) **Generation 7**

Zone Status Screen

This screen allows the user to monitor Zone Temperature status and PID Outputs. The PID outputs also appear in the Maintenance Screen.

Figure 50:

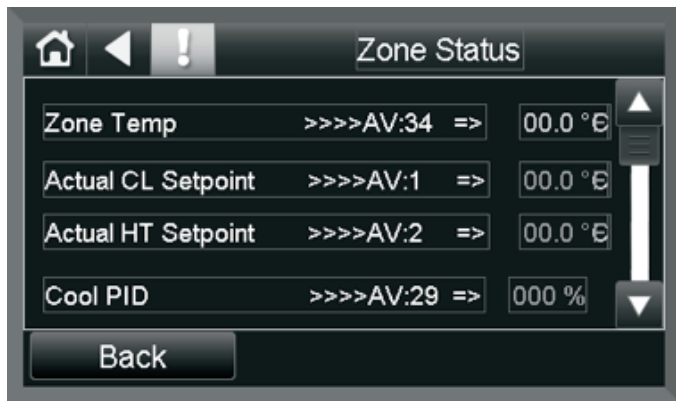

- 1. Zone Temp**- Reports the Zone or Room Air Temperature. It will be in F° or C° depending on the status of the “Metric” Control Point (BV:39).
- 2. Actual CL Setpoint**- Reports the Actual Cooling Setpoint that includes the Master Setpoint plus/minus adjustments the user has made. It will be in F° or C° depending on the status of the “Metric” Control Point (BV:39).
- 3. Actual HT Setpoint**- Reports the Actual Heating Setpoint that includes the Master Setpoint plus/minus adjustments the user has made. It will be in F° or C° depending on the status of the “Metric” Control Point (BV:39).
- 4. Cool PID**- Displays the output of the cooling PID calculation. Will be between 0 – 100 %. This value also appears in the Maintenance Screen.
- 5. Heat PID**- Displays the output of the heating PID calculation. Will be between 0 – 100 %. This value also appears in the Maintenance Screen.

Sensor Setup/ Status Screen

The Sensor Setup/Status screen allows access to the RNet Sensor Setup sub-screen and the RNet Sensor Active Screen. It contains the RS Sensor Status and the Sensor Alarm Status. It also has a check box for enabling the internal Equipment Touch Temp and Humidity sensors.

Figure 51:

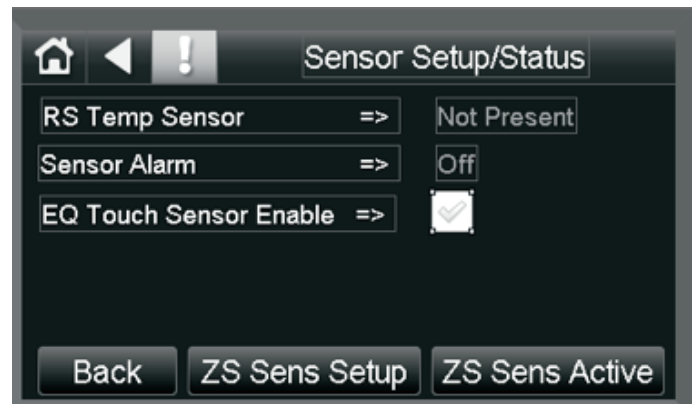

- 1. RS TEMP Sensor**- Status of the RS Temperature Sensor, Present or Not Present.
- 2. Sensor Alarm** - ON if one of the RNet Sensors enabled is missing or not functional.
- 3. EQ Touch Sensor Enable**- Checked to enable internal Equipment Touch Sensors.

Equipment Touch Screen Descriptions (Water-to-Air) **Generation 7**

RNet (ZS) Sensor Setup Screen

Password Protected

This screen allows access to the Enables for the RNet Sensor Alarms. If a Sensor is installed, the associated Alarm Enable must be checked for it to generate an alarm when not present or non-functional.

Figure 52:

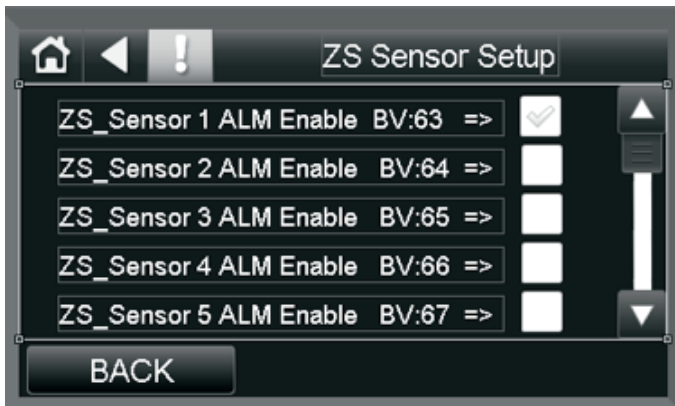

- 1. RNet Sensor 1 Alarm Enable-** Checking this will tell the sensor alarm logic to expect a valid sensor to be present at Address 1. If it is not present, a Sensor Not Present Alarm will be generated. This is required because the unit can have up to 5 zone sensors and is set to look for all 5 even when only one or two are present. (It is normally defaulted to checked.)
- 2. RNet Sensor 2 Alarm Enable-** Checking this will tell the sensor alarm logic to expect a valid sensor to be present at Address 2.
- 3. RNet Sensor 3 Alarm Enable-** Checking this will tell the sensor alarm logic to expect a valid sensor to be present at Address 3.
- 4. RNet Sensor 4 Alarm Enable-** Checking this will tell the sensor alarm logic to expect a valid sensor to be present at Address 4.
- 5. RNet Sensor 5 Alarm Enable-** Checking this will tell the sensor alarm logic to expect a valid sensor to be present at Address 5.

RNet (ZS) Temp Sensor Active Screen

This screen shows which RNet Sensors are detected and present within the system.

Figure 53:

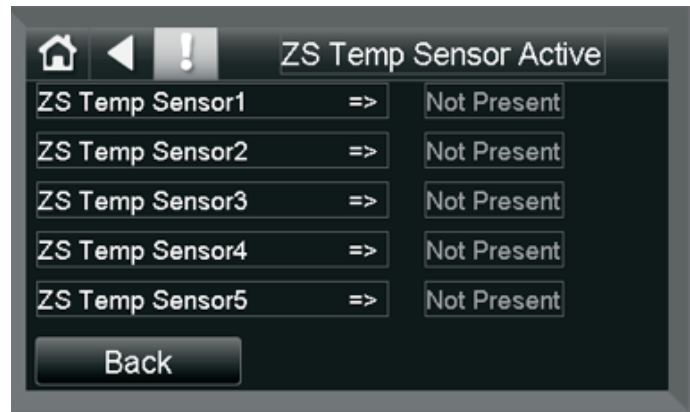

- 1. RNet Sensor 1-** Address 1, Present or Not Present
- 2. RNet Sensor 2-** Address 2, Present or Not Present
- 3. RNet Sensor 3-** Address 3, Present or Not Present
- 4. RNet Sensor 4-** Address 4, Present or Not Present
- 5. RNet Sensor 5-** Address 5, Present or Not Present

Equipment Touch Screen Descriptions (Water-to-Air) **Generation 7**

Mode Settings

Password Protected

This screen contains mode settings used to configure and test the MPC unit.

Figure 54:

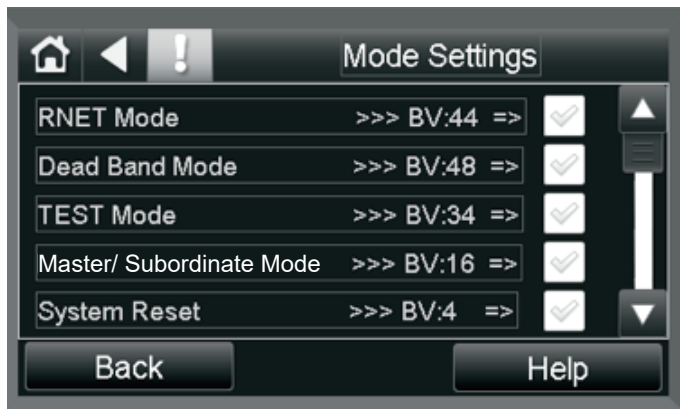

1. **RNet Mode**- allows the MPC to function with LStat Sensors when RNet is OFF. Also allows monitoring of inputs 5 and 6 (temp or dry contact) when a RNet sensor is used.
2. **Dead Band Mode**- DB Mode forces a user selectable dead band between heat and cool set points. Example: if the heat set point is lowered by 2 degrees then the cool set point will also be lowered by 2 degrees.
3. **Test Mode**- Shuts everything down so that the Compressors, Supply Fan and Reversing Valve can be tested manually via their associated manual control points.
4. **Master/Subordinate Mode**- Checking this box puts the unit in Subordinate Mode.
5. **System Reset**- Reset the MPC.

Initial Sensor Setup

Revision 7 and higher software can handle up to 5 -RNet Sensors connected in parallel or one RS Sensor (Obsolete). The Equipment Touch itself can also function as a Temperature/humidity Sensor in place of the RNet/RS Sensors. Setup and screens related to sensor function is covered below.

RNet Sensor Setup

The RNet Sensor address must be between 1 and 5. Set the address on the back of the sensor as required. It is best to start at sensor number 1 and increase the address for each additional unit connected. Make sure all of the required sensors are wired to the RNet Connector correctly.

Equipment Touch has an alarm feature that will activate an alarm if the Alarm Enable is selected and no sensor is present. The alarm will reset automatically when a sensor is plugged in.

To configure the Equipment Touch for RNet Sensors, Navigate to the following menu
(RNet (ZS) Sensor Setup)

Figure 55:

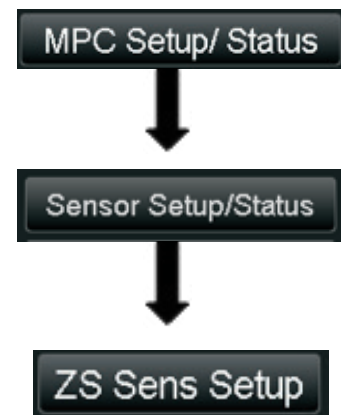

Equipment Touch Screen Descriptions (Water-to-Air) **Generation 7**

Click or select the appropriate RNet Sensor Alarm Enable button for the number of sensors installed and their associated addressing. In the figure below, only one RNet Sensor is installed so only Address 1 is selected.

Figure 56:

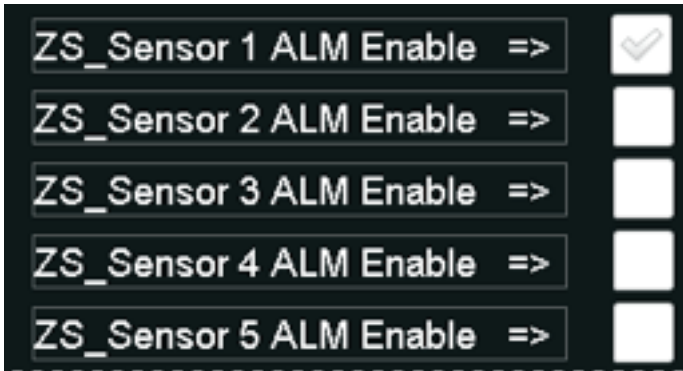

To confirm you are seeing the RNet Sensors, navigate to the ZS Sens Active screen.

Figure 57:

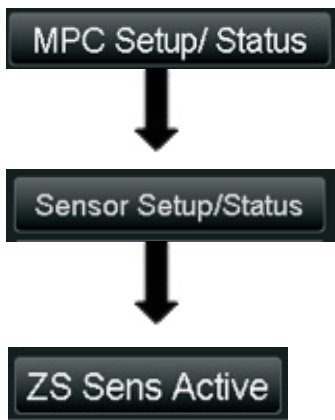

This will take you to the RNet Active screen which allows you to see if a individual sensor is present.

Figure 58:



This is all that is required to setup for running RNet sensors with the Generation 7 Version of the MPC.

Equipment Touch Setup

To use the Equipment Touch as the Wall Sensor, it must first have the internal Temperature and Humidity sensors enabled so they can transmit this data. To do this, navigate to the Sensor Setup screen.

Figure 59:

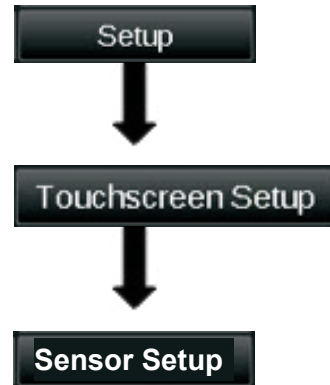

1. Set Temperature Sensor to "internal" and Enable Transmit to ON.
2. Set Humidity Sensor Enable transmit to ON.
3. Then press SAVE

The next step is to navigate to the Sensor Setup/ Status screen and make sure the Equipment Touch Sensor Enable is checked.

Figure 60:

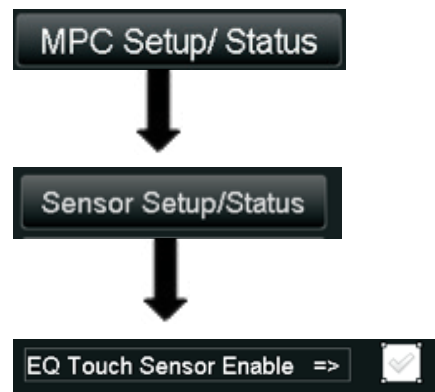

Equipment Touch Screen Descriptions (Water-to-Air) **Generation 7**

Generating a Field Archive

To archive the current MPC Download, navigate to the Archive screen and click the "Archive Now" check box.

Figure 61:

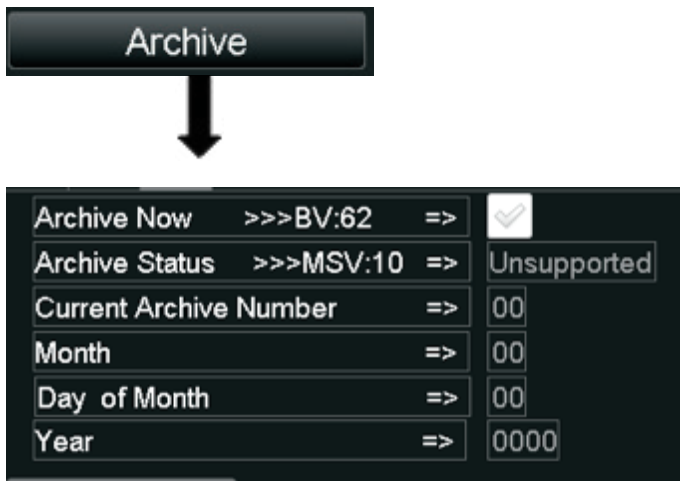

When the "Archive Now" box is checked the MPC will archive the current modified program including all control settings and display the current archive number, Month, Day and Year of the archive will be displayed. See above information on retrieval procedures.

Test Mode

Test Mode allows the field personnel to manually manipulate the following for troubleshooting purposes:

1. Compressor 1
2. Compressor 2
3. Supply Fan
4. Reversing Valve

To enter Test Mode, navigate to the Mode Settings screen. Check the box for Test Mode. When navigating to the maintenance screen, the icon for Test Mode will be displayed and the icons for C1, C2, RV and Fan will not be displayed.

Figure 62:

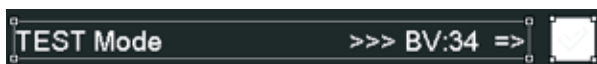

The correct test sequence is shown below: Note the Compressors will not turn on unless the Supply Fan is on, so it must be turned on first.

Figure 63:



1. To test the supply fan, navigate to the Fan/Filter Control screen and check the "Supply Fan Manual" box. Check the maintenance screen to ensure the fan icon is present.
2. To test the compressors, navigate to the Compressor Setup Screen. Once here, the compressors may be turned ON or OFF via the Manual Compressor Check Boxes. The icons on the maintenance screen will appear when the compressors are turned ON and disappear when the compressors are turned OFF.

Figure 64:

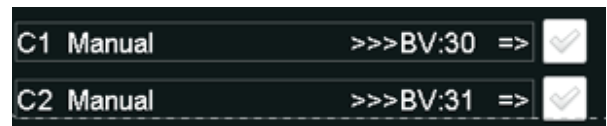

3. To test the Reversing Valve function, navigate to the HEAT/COOL Control screen and check the "Reversing Valve Manual" check box. You can verify that the RV Icon appears on the maintenance screen when the RV is turned on.

Figure 65:

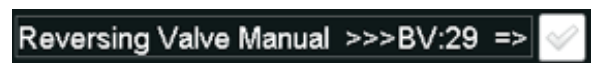

Notes:

This Page Was Intentionally Left Blank

Due to ongoing product improvements, specifications and dimensions are subject to change and correction without notice or incurring obligations. Determining the application and suitability for use of any product is the responsibility of the installer. Additionally, the installer is responsible for verifying dimensional data on the actual product prior to beginning any installation preparations.

Incentive and rebate programs have precise requirements as to product performance and certification. All products meet applicable regulations in effect on date of manufacture; however, certifications are not necessarily granted for the life of a product. Therefore, it is the responsibility of the applicant to determine whether a specific model qualifies for these incentive/rebate programs.

Comfort-Cire® **Century**®

1900 Wellworth Ave., Jackson, MI 49203 • Ph. 517-787-2100 • www.marsdelivers.com

